



Stock Code  
688026

●JET · Head Quarter

No.1 DouTang Road, YongHe Development Zone, Guangzhou, China 511356  
Guangzhou Jet Bio-Filtration Co., Ltd.  
Tel: +86-20-32811888 Fax: +86-20-32811888  
E-mail: jetbiofil@jetbiofil.com

●JET · South America Office

Gral. Alvear 123, 1° of. 5 Lomas de Zamora (B1832BVC),  
Buenos Aires, Argentina  
Tel : (+5411) 42921611  
E-mail : info@apbiotech.com.ar www.apbiotech.com.ar

●JET · Europe Office

Akralab, S.L. Pol. Ind. Las AtalayasAv. de la Antigua Peseta,  
77 03114 Alicante · Spain Buz“(R)n 202  
Tel : +34 965 11 65 21 Fax :+902 22 22 75  
mariano.guzman@akralab.es www.akralab.es

●JET · US Office

1551 South Acottdale Court Suirt 200,Elgin IL,60123  
Tel : +8057667534 E-mail : Dannie@jetbiofil.com

●JET · Korea Office

DAIHAN Bidg., 24-4, sangwolgok-dong, Seongbuk-gu, Seoul, Korea  
Tel : 82-33-737-7513/7516 Fax : +82-33-737-7509/7529  
E-mail : jacechoi@daihansci.co.kr

●JET · Japan Office

32-206 Mibuaiai-cho, Nakagyo-ku Kyoto-city, Kyoto 604-8812  
Tel : +81-75-334-282 Fax : +81-75-822-2194  
E-mail : kooki@jc5.so-net.ne.jp

●JET · Israel Office

16 Hashmelai st. Emek Sara, Be'er Sheva, HaDaron, Israel, 8487419  
Tel : 972-8-6280210 Fax : 972-8-6280801  
E-mail : sales@romical.com

WWW.JETBIOFIL.COM

YOUR RELIABLE PARTNER IN LIFE SCIENCE



2021.02



CATALOGUE

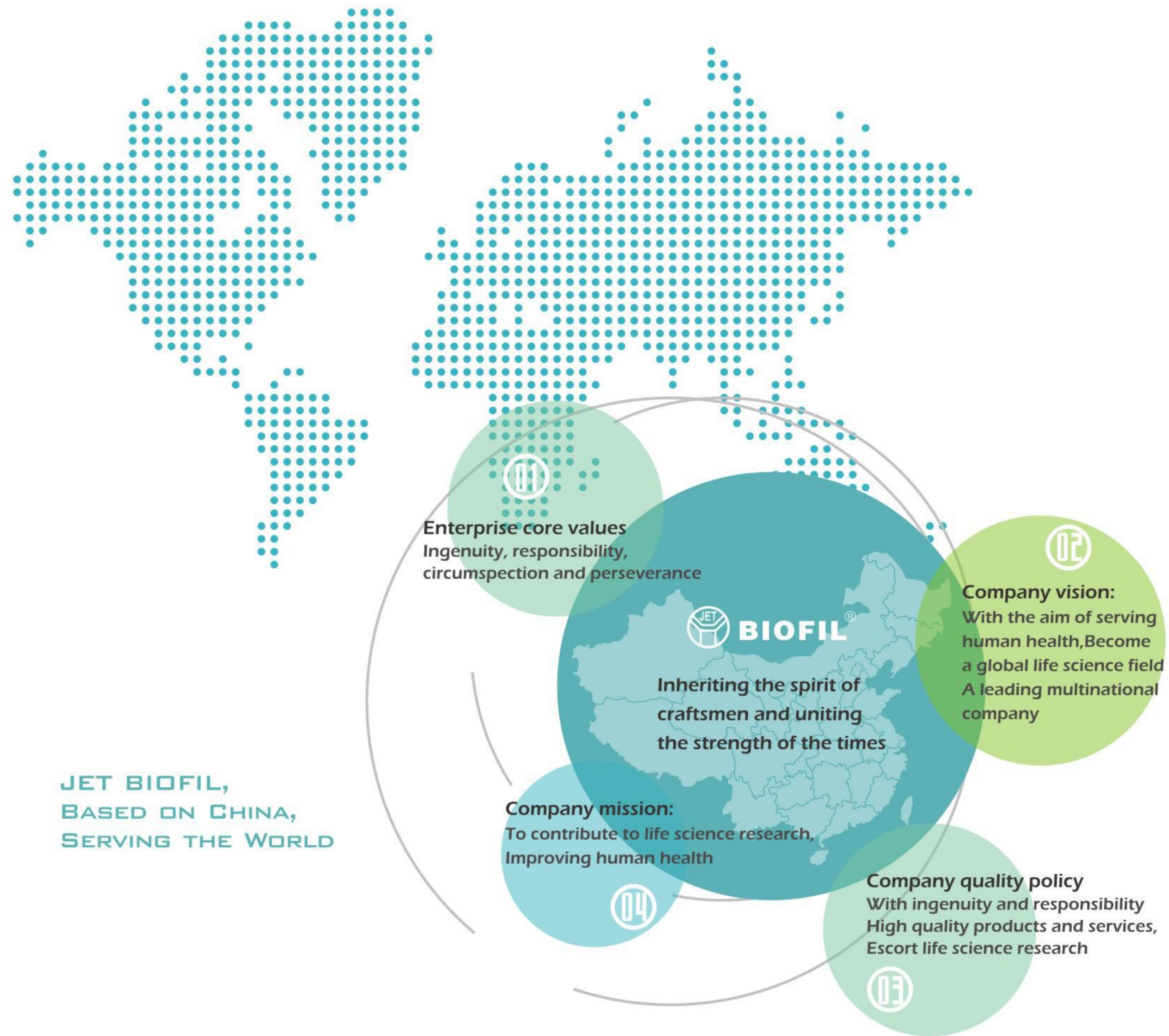

# ENTERPRISE MILESTONE

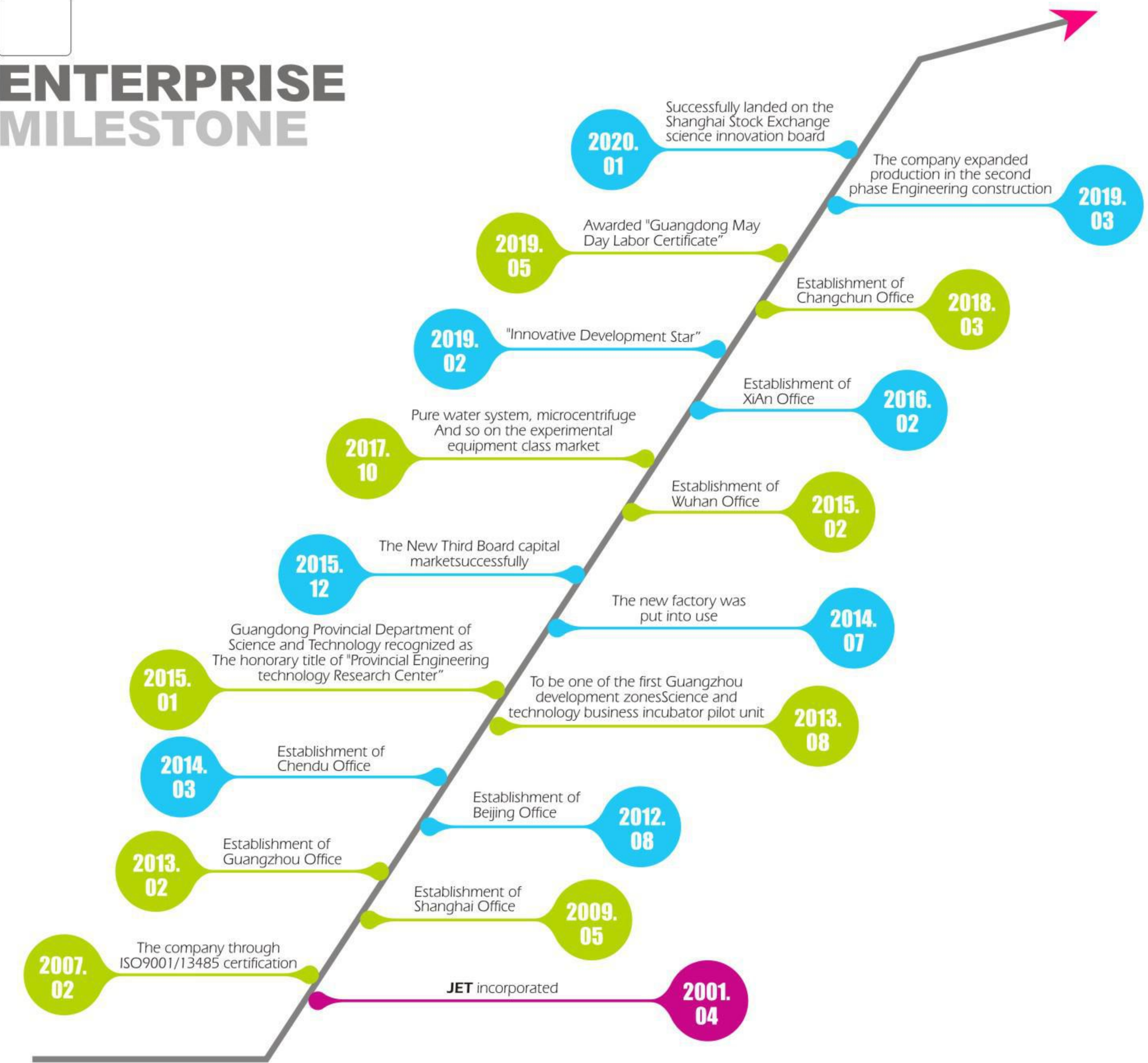



## COMPANY INTRODUCTION

YOUR RELIABLE PARTNER IN LIFE SCIENCE

Guangzhou Jet Bio-Filtration Co; Ltd. was found in 2001 and is a well-known company in China involving R&D, manufacturing and sales of laboratory consumable products. It covers an area of 22,468m<sup>2</sup> in the scenic Science City. So far, the company has distributors in more than 50 countries all around the world, including America, Japan ,Canada, Germany, Australia and Korea. It has set up offices in several domestic cities like Shanghai, Beijing, Chengdu, Wuhan and Guangzhou. Its main products include laboratory consumables ( pipettes, tissue culture products, centrifuge tubes, filtration products etc...), analyzer, lab equipment, reagent and culture medium, which have all been certified by ISO 9001/13485 and CE quality management system. Our goal is to provide innovative solutions and premier service and maximize customer value.

## Company Environment









03

04



## Product List

### Tissue Culture Products

Erlenmeyer Flash .....	07
Disposable Virus Sampling tube .....	08
JET CellFac® Products .....	09
CellBOX™ .....	12
JET CellSCAFOLD® 3D Cell Culture Products .....	13
JET CellSLIP® Cell Slide .....	15
Confocal Dish .....	16
CellDETA™ Temperature-Responsive Cell Culture Surface .....	17
CellATTACH® Surface Products .....	19
Cell and Tissue Culture Plates .....	21
Polycarbonate (PC) Membrane Tissue Culture Plate Inserts .....	23
Polyester (PET) Membrane Tissue Culture Plate Inserts .....	23
Cell Culture Inserts .....	24
Cell and Tissue Culture Flasks .....	25
600ml Tissue Culture Extended Flasks .....	26
Cell and Tissue Culture Dishes .....	27
6cm Cell and Tissue Culture Center-well Dish .....	28
L-shaped Cell Spreader .....	29
Flat Blade Cell Lifter .....	29
Medium Bottles .....	30
Solution Bottles .....	30
Cell Scrapers .....	31
Rotatable™ Cell Scrapers .....	31
Inoculating Loops and Needle .....	32
Freezing Vials .....	33
Cell Strainers .....	35
Pestles for Cell Strainer .....	35
Bio-Reaction Tubes .....	36
Culture Tubes .....	36
Roller Bottles for Cell and Tissue Culture .....	37
Round-Bottom Tubes with Dual-position Cap .....	37
Single well plates .....	38
96 Well Detachable Flat Plate .....	38

### Pipette Products

Serological Pipets .....	40
Mini™ Serological Pipets .....	42
Aspirating Pipets .....	42
Transfer Pipets .....	43
Plastic Pasteur Pipets .....	44
Pipette Controller .....	44
Micro Volume Pipettors .....	45
Multichannel Micro Pipettors .....	45
JET Dispenser .....	46

### Centrifuge Tubes Products

Centrifuge Tubes .....	47
High Performance Centrifugal Tube .....	48
Amber Centrifuge Tubes .....	48
SureSeal™ 50ml Centrifuge Tubes .....	49
Metal-Free Centrifuge Tubes .....	49
30ml Centrifuge Tubes .....	49
15ml PS Centrifuge Tubes .....	50
Plastic Centrifuge Tube Racks .....	50
Centrifuge tube stand .....	51
Conical Centrifuge Bottles .....	51
Easy Flip™ Centrifuge Tubes .....	52
Easy Flip™ 1.5ml Micro Centrifuge Tubes .....	52
Pestles for 1.5ml Micro Centrifuge Tubes .....	53
Micro Centrifuge Tubes .....	53
Screw Cap™ Micro Centrifuge Tubes .....	55

### Filtration Products

Syringe Driven Filters .....	56
Syringe Driven Filters(50ml) .....	58
Vacuum Filtration .....	59
Filter Upper Cup .....	61
Centrifugal Filters .....	62
Tube Top Vacuum Filters .....	63

### Pipette Micro Tips

ZEROTIP™ Pipette micro Tips .....	64
Pipette Micro Tips .....	66
Robotic Tips .....	68

### Other Laboratory Products

Petri Dishes .....	75
Reagent Reservoirs .....	75
Reagent Reservoirs .....	76
PCR Tubes .....	76
96 Well PCR Plates .....	76
Deep-well Multiwell Plates .....	77
Sample Library Tube .....	77
Serum & Sample Tubes .....	78
Cuvettes .....	78
Graduated Urine Centrifuge Tubes .....	78

# Tissue Culture Products

Cell and Tissue Products series, including CellDETACH™ Temperature-Responsive Culture Surface Products, CellTATCH® Surface Products, Cell and Tissue Culture Products, Roller Bottles, Bio-Reaction Tubes and so on, are all innovatively designed by JET engineers and manufactured in 100,000 grade clean room environment under the control of ISO 9001 and ISO 13485 quality management system. All the JET BIOFIL Products are manufactured with 100% USP VI crystal class virgin polystyrene(GPPS) and equal high quality polyethylene(PE) to eliminate all extraneous materials and ensure the integrity cells. Furthermore, the high transparency of high class material ensures good observability. In addition, all the products are sterilized by gamma irradiation and certified DNase/RNase free and non-pyrogenic. Products are modified with vacuum gas plasma causing the very hydrophobic polystyrene surface to become negatively charged and hydrophilic, allowing cells to attach evenly and consistently. And our own technological transformed vacuum-gas plasma machine has been applied to adherent and suspension cell lines.



**Erlenmeyer Flask** New Listing



Erlenmeyer Flask is suitable for the culture of cell lines with high requirements on oxygen. It can also be used for the culture of bacteria, fungi and animal and plant cells in suspension. Compared with the culture bottle, dish and transflask, it requires less work.

**Product Description**

- \* Made from optically clear polycarbonate or PETG
- \* Available with 3 volumes of 125ml, 250ml and 500ml
- \* Ideal for shaker culture applications and storage
- \* Molded-in graduations for accuracy (±5%)
- \* Vent cap option for continuous gas exchange while ensuring sterility and preventing leakage
- \* PC material can be autoclaved once at 121°C and freezable to -80°C
- \* Sterilized by gamma irradiation
- \* RNase-/DNase-free, Non-pyrogenic
- \* Leak-proof

**Ordering Information**

PETG, General, No-treated

Cat.No	capacity(ml)	Sterile	Cap Styles	Qty. per bag/case
TAB101125	125	Y	Standard	1/24
TAB102125	125	Y	Vent	1/24
TAB101250	250	Y	Standard	1/12
TAB102250	250	Y	Vent	1/12
TAB101500	500	Y	Standard	1/12
TAB102500	500	Y	Vent	1/12

PC, General, No-treated

Cat.No	capacity(ml)	Sterile	Cap Styles	Qty. per bag/case
TAB001125	125	Y	Standard	1/24
TAB002125	125	Y	Vent	1/24
TAB001250	250	Y	Standard	1/12
TAB002250	250	Y	Vent	1/12
TAB001500	500	Y	Standard	1/12
TAB002500	500	Y	Vent	1/12

**Disposal Virus sampling tube**

It is composed of nylon staple fiber villus head and medical grade PP plastic rod, which is 3 times higher than the traditional swab sample collection and release, ensuring the survival rate of cell samples and no residual fatty acids, which will not affect the experimental detection effect, and it is widely used in the field of gene detection.

The JET BIOFIL sampling swab set consists of a swab and a liquid based cell preservation solution. After the swab is collected, the sample is stored in the liquid based cell preservation solution to ensure the DNA integrity of the sample, and can be transported and stored for a long time at room temperature.

**Application:**

Cytology sample processing, virology cell culture, DFA test, elisa test, PCR test, molecular diagnosis, blight test, etc.

**Product Description**

- \* Good sampling effect, sample collection and release up to 95%
- \* Unique process, increase the comfort of the collector
- \* Ethylene oxide sterilization, no inhibition to subsequent application
- \* The folding point design on PP bar is saved according to different sample retention requirements
- \* Samples can be stored for 12 months at room temperature
- \* The swab set is a combination of 1 piece of swab and 1 part of preservation solution, with one swab collection per person
- \* Can be customized according to customer needs



**Instructions for use**

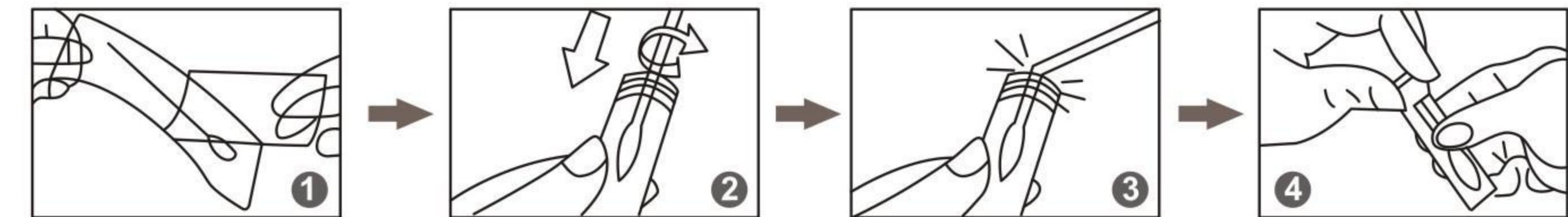

1. Unwrap the package, take out the swab.
2. Use the swab to collect samples and put it back into the tube.
3. Break the swab rod and leave the sampling parts inside the tube.
4. Screw the lid tightly and mark on the tube.



**Ordering Information**

Cat.No	Describe
CY1002010	10ML sampling tube + 3ml preservation solution, nasal flocking swab + throat flocking swab, no sterilization, 50 pieces/box, 1200/ box

## JET CellFac® Products

In the past ten years, due to the rapid development of biological products, the traditional method of obtaining biological products from animal tissues by biochemical technology has been far from meeting the needs of the market, and in vitro large-scale culture of animal cells which is applied to express specific proteins, monoclonal antibodies and interferon and product virus vaccine has become the most common technology currently.

At present, the common methods of cell culture include conventional cell culture dish, plate, flask, roller bottle, bioreactor, etc. The above cell culture devices have the following serious defects:

1) the unit volume of cell culture vessel and apparatus provides a surface area for cell growth, cell growth density is low, the number of harvested cells in a single culture is low, and a large amount of materials, labor and time are needed in repeated cultures.

2) conventional cell culture dish, plate and bottle are all open type, so contamination is prone to happen in the process of liquid adding, inoculation and cell harvesting.

JET CellFac® Products developed by JET is made from medical-grade general purpose polystyrene (GPPS) that is a polymer (patent number:ZL201220167380.4ZL201220167162.0), and is an ideal tool for large-scale cell culture and the production of cellular drug.

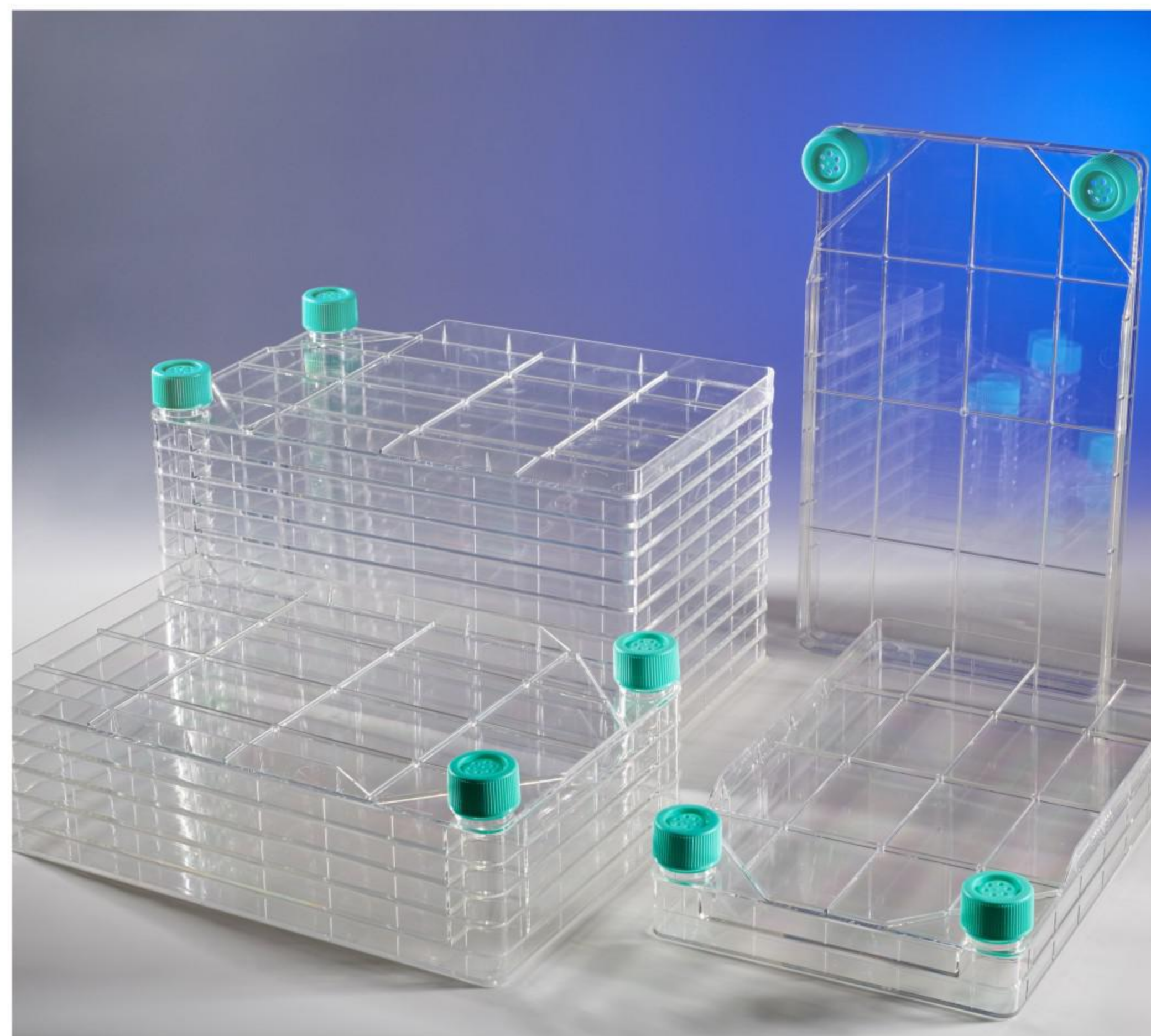

- \* The culture device with monolayer or up to 10 layers can realize large-scale cell culture by one time
- \* Available in surface treated, or non-treated
- \* The device is assembled by hydrophobic membranes with a aperture of 0.22μm to avoid potential contamination in gas exchange
- \* The device does not absorb cytokines and growth factors, and conventional trypsin digestion method is applied in cell harvesting
- \* Strict integrity tested
- \* Sterilized by gamma irradiation
- \* Non-pyrogenic & DNase/RNase-free

### Ordering Information

- \* Individually packaged in peel-to-open plastic blister pack
- \* Every case has printed with lot No. for quality traceability

## Guidelines For Use



Pour the media directly into the Cell Factory system



Equilibrate by placing the Cell Factory system on the side with the small port



Turn 90° so the filling inlet is in an upward position. The medium will be separated, with equal amounts in each chamber



Carefully tilt the Cell Factory system to a horizontal incubation position with the filling inlet up



Incubate following appropriate protocol



Loosen the cap and empty directly into the reservoir

Cat.No	Layers Qty.	Appro.Cell Growth Area(cm <sup>2</sup> )	Working Volume(ml)	Material	Description	Sterile	Qty.per bag/Case
UCF010001	1	656	130-200	PS/HDPE	Non-Treated, Vent Cap	Y	1/8
UCF010002	2	1296	260-400	PS/HDPE		Y	1/6
UCF010005	5	3216	650-1000	PS/HDPE		Y	1/4
UCF010010	10	6416	1300-2000	PS/HDPE		Y	1/2
UCF011001	1	656	130-200	PS/HDPE	Surface Treated, Vent Cap	Y	1/8
UCF011002	2	1296	260-400	PS/HDPE		Y	1/6
UCF011005	5	3216	650-1000	PS/HDPE		Y	1/4
UCF011010	10	6416	1300-2000	PS/HDPE		Y	1/2

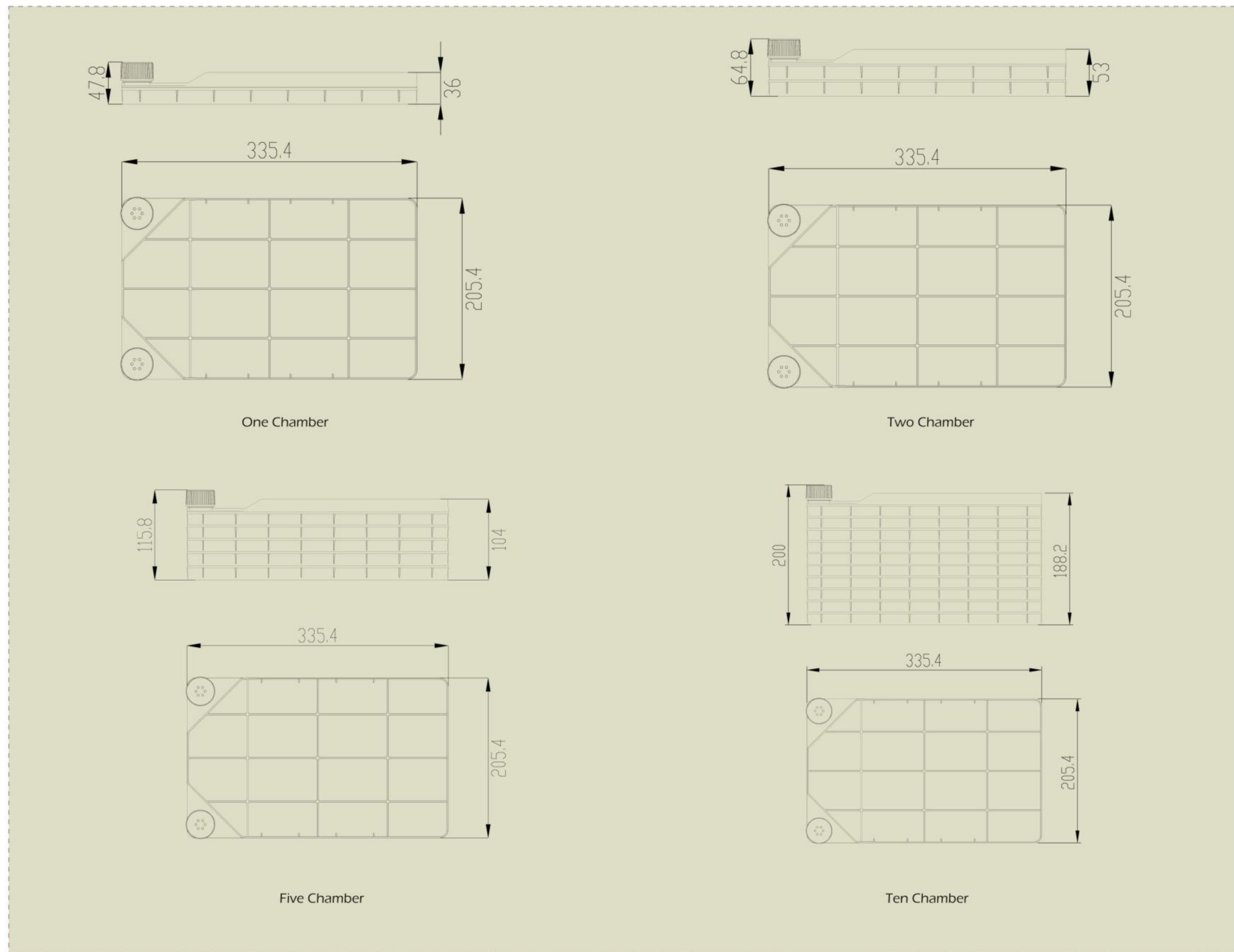

### CellBOX™

- \* Made from high grade gamma resistance polystyrene
- \* The culture device with monolayer or up to 10 layers can realize large-scale cell culture by one time
- \* Easy to use and standardized operation ensures uniform cell growth
- \* Suitable for most adherent cell lines
- \* Linear amplification, easy to expand to the industrial scale
- \* Transparent material can be observed directly under a microscope
- \* Modular design can be multi-level series or parallel
- \* It can be equipped with a variety of online monitoring instruments
- \* Strict integrity tested
- \* Sterilized by gamma irradiation
- \* DNase/RNase-free, Non-pyrogenic

Cat.No	Description	Sterile	Qty.per bag/Case
CBX010001	1 layer, Surface Treated	Y	1/8
CBX010010	10 layers, Surface Treated	Y	1/8

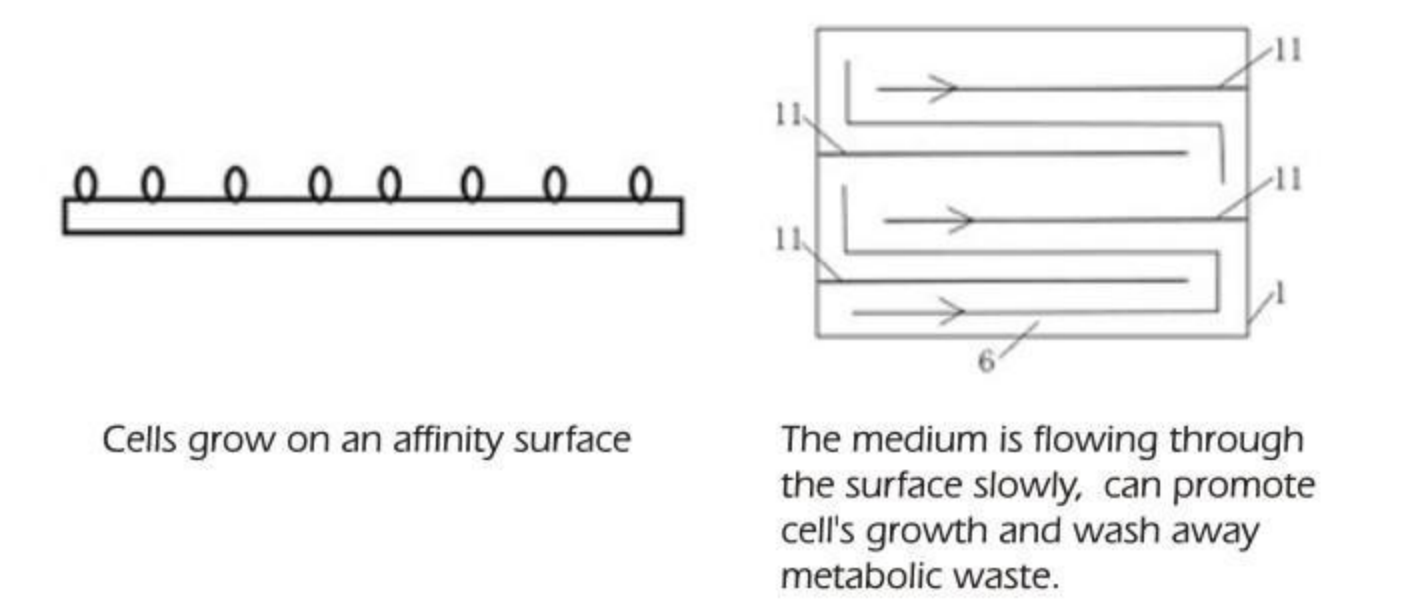

#### Corollary Equipment



## JET CellSCAFLD® 3D Cell Culture Products



JET CellSCAFLD® 3D cell culture series include culture plates with 6, 12 and 24 wells and culture dishes in sizes of 35mm, 60mm and 70mm. They are all made of polystyrene (GPPS), a high molecular material. 3D scaffold for cell culture is able to simulate the three-dimensional structure of the cells in animals and the human body to the maximum extent, to provide an ideal environment for the interaction between cells, to greatly improve culture area, and to extremely improve the yield of cell culture. JET 3D scaffold for cell culture which is a patented product (patent number: ZL201620728244.6, ZL201620728243.1, 201510783345.3) is an ideal tool for three-dimensional cell culture, cell-cell interaction mechanism, cell immunotherapy, stem cell therapy, drug screening and the production of cellular drug.

- \* The whole 3D scaffold for cell culture is made from polystyrene that is a polymer, with a mean wire diameter of 500m, a mean wire spacing of 260m, and high regularity. The product is structured with 3-dimensional channels, and has extremely high connectivity, facilitating the transmission of nutrients, the consistency of metabolic activity and the accuracy of culture results in 3D cell culture
- \* 3D cell culture is more likely to the expression of cell functions as compared with 2D, and simulates the three-dimensional structure of the cells in animals and the human body to the maximum extent, providing an ideal environment for the interaction between cells
- \* Polystyrene-made, cytokine and growth factor resistant, easy cell secretion collection, time-saving and free from extra separating steps
- \* Open pores with high connectivity, facilitating nutrient absorption and metabolism
- \* 3D scaffold with larger surface area than regular cell culture products, material efficient
- \* Strict integrity tested
- \* Sterilized by gamma irradiation
- \* Non-pyrogenic & DNase/RNase-free

There are four layers in one scaffold. And 4 different colors corresponding that. From plan view and vertical view. In accordance with both pictures, obviously showing this structure consisting of four layers of fibre, waved vertical to each other, and not overlapping.

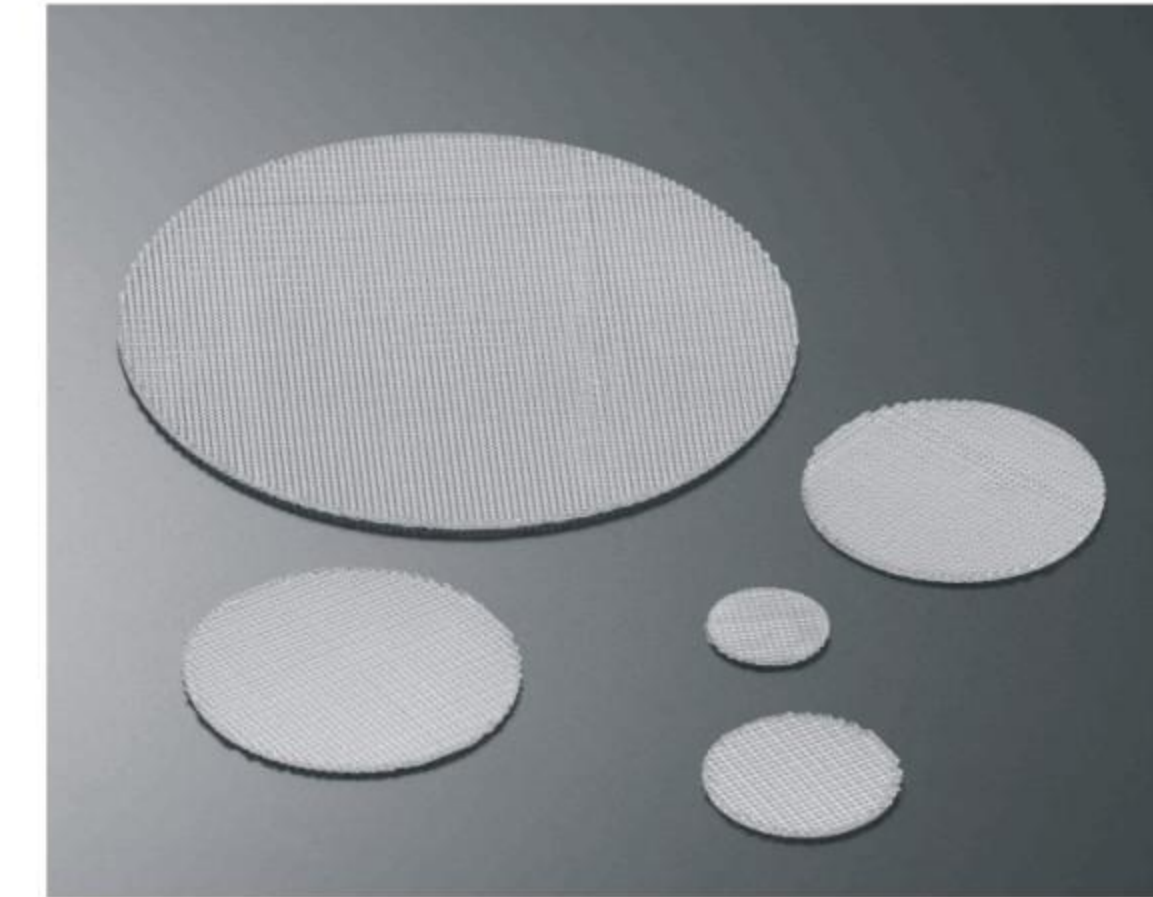
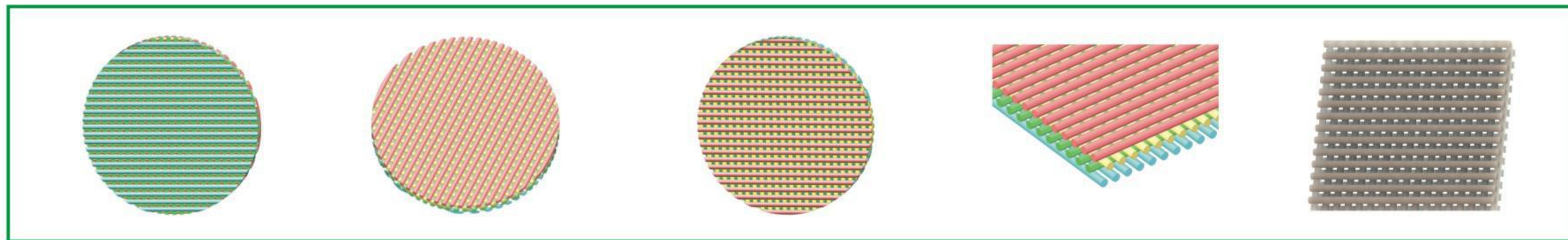

### 3D Cell Culture Plate

Cat.No.	Well Qty.	Scaffold Inserts in Package	Size		Description	Scaffold Dimension (mm)	Surface Area(cm <sup>2</sup> )	Sterile	Qty. per bag/case
			Fiber Diameter(μm)	Pore Width(μm)					
TDP032006	6	3	500	260	Standard, Surface treated	33.5*1.6	143	Y	1/8
TDP032012	12	6	500	260		21.0*1.6	113	Y	1/8
TDP032024	24	12	500	260		15.0*1.6	115	Y	1/8

### 3D Cell Culture Dish

Cat.No.	Well Qty.	Scaffold Inserts in Package	Size		Description	Scaffold Dimension (mm)	Surface Area(cm <sup>2</sup> )	Sterile	Qty. per bag/case
			Fiber Diameter(μm)	Pore Width(μm)					
TDD032035	3.5	1	500	260	Standard, Surface treated	32.0*1.6	43	Y	1/40
TDD032060	6.0	1	500	260		51.0*1.6	109	Y	1/30
TDD032070	7.0	1	500	260		67.5*1.6	191	Y	1/30

### Easy to Use



1 Prepare the required volume of cell suspension.

2 Add the cell suspension to the 3D Scaffold slowly.

3 Ensure that the 3D Scaffold is fully covered with cell suspension and avoid overflow.

4 Use tweezers to pick up the 3D scaffold and place it into the tissue culture dish.

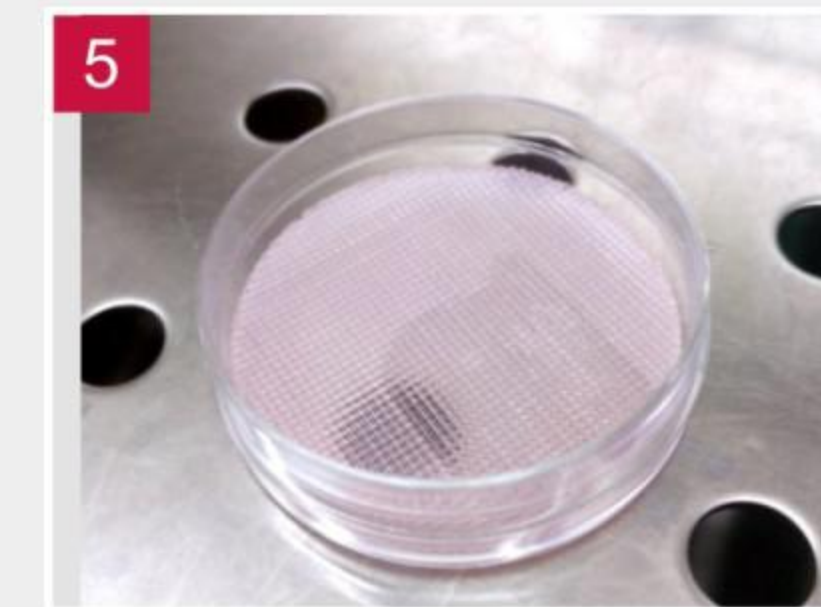

5 After finishing vaccinal cell, put the dish into a 37°C and 5% CO<sub>2</sub> incubator for culturing for three hours.

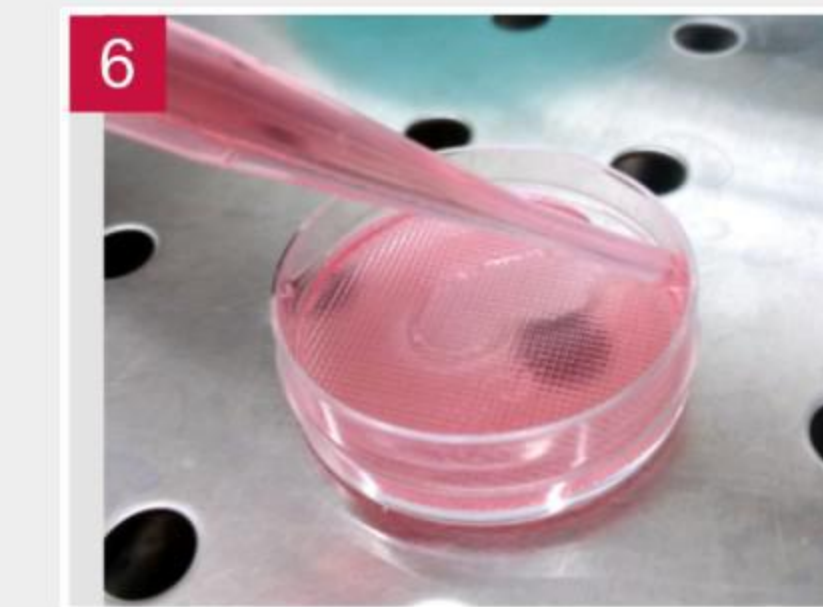

6 After three hours, slowly add the cell culture medium through the dishes internal wall.

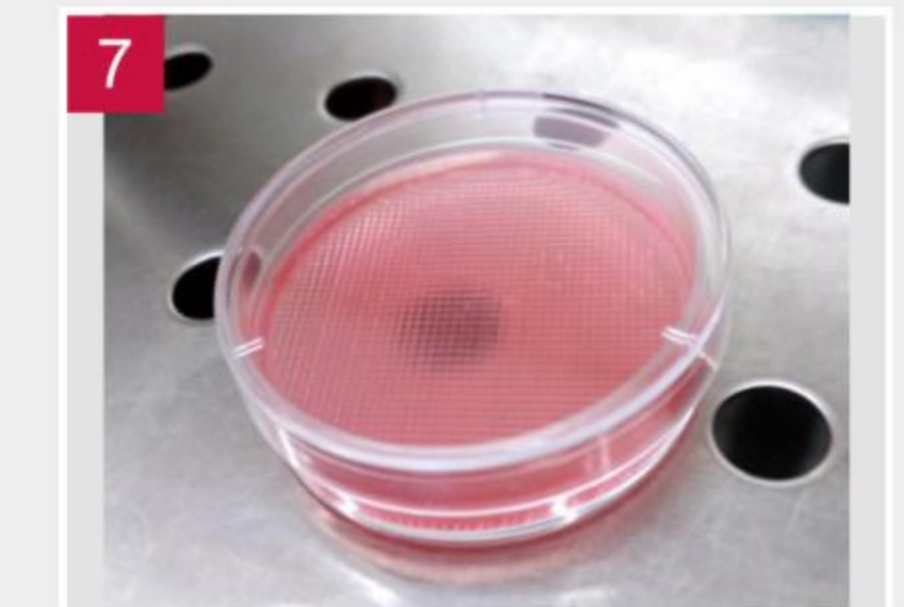

7 Place the 3D Scaffold into the incubator once the cell culture medium covers the Scaffold completely.



## JET CellSLIP® Cell Slide

With the continuous updating and rapid development of life sciences research, technical indexes analyzed and observed by cell culture experiment are increasing, and their covered fields are expanding. Cell slide is a material of in vitro cell experiment achieved by adherent cells growing adherent to a certain solid surface (e.g., cover glass, slide glass) according to requirements for experimental research. HE staining and immunocytochemistry of a large number of cell slides are often required in many research projects with massive samples and numerous indicators to be measured. However, routine cell slides used currently have serious defects. For instance, cell slides are prone to be damaged because they are made of glass; cell slides are difficult to control due to no handle; cells can grow in any part of the cell slide and their container when culturing, etc. JET cell slide and culture dish which is a patented product (patent number: ZL201520113833.9, ZL201420594580.7, ZL201420594259., ZL200610047607.0) solves various defects of existing cell slides and contributes to simple and easy operation of above experimental studies and application.

- \* The cell slide is made from PET, has high strength and is unbreakable
- \* Only the surface of the cell slide undergoes high hydrophilic treatment, so cells are easy to grow adherent to the cell slide; while other parts receive hydrophobic treatment, thus cells are difficult to grow
- \* There are 2 specifications with different diameters: 8 and 10mm; the number of cell slides with single dish: 12/18/32/45
- \* Transparency and light transmittance of the cell slide are good; therefore, cells can be clearly observed under a light microscope and a fluorescence microscope
- \* The specific set structure of the cell slide can realize the development of multi-factor, multi-index and multi-level in vitro study under the same conditions, resulting in accurate and reliable research results
- \* Cell culture once can prepare multiple cell slides for different studies and objectives, increasing work efficiency;
- \* The handle of the cell slide tilts with a certain angle, which is convenient for operators to directly clamp. The handle is engraved with numbers, facilitating identification
- \* The product and forceps for the cell slide are both sterilized with gamma ray, and should be used immediately after opening
- \* DNase/RNase-free & Non-pyrogenic

### Ordering Information

- \* The cell slide is made from medical-grade high-transparent PET/PETG, the culture surface undergoes high hydrophilic treatment
- \* The integrated cell slides are fixed in the culture dish; if further test is necessary after cell culture, the cell slides can be taken out one by one and placed in a culture plate or other containers with a corresponding specifications
- \* Each box of products is matched with individually packed sterile metal tweezers
- \* Individually packaged in peel-to-open plastic blister pack
- \* Every case has printed with lot No. for quality traceability

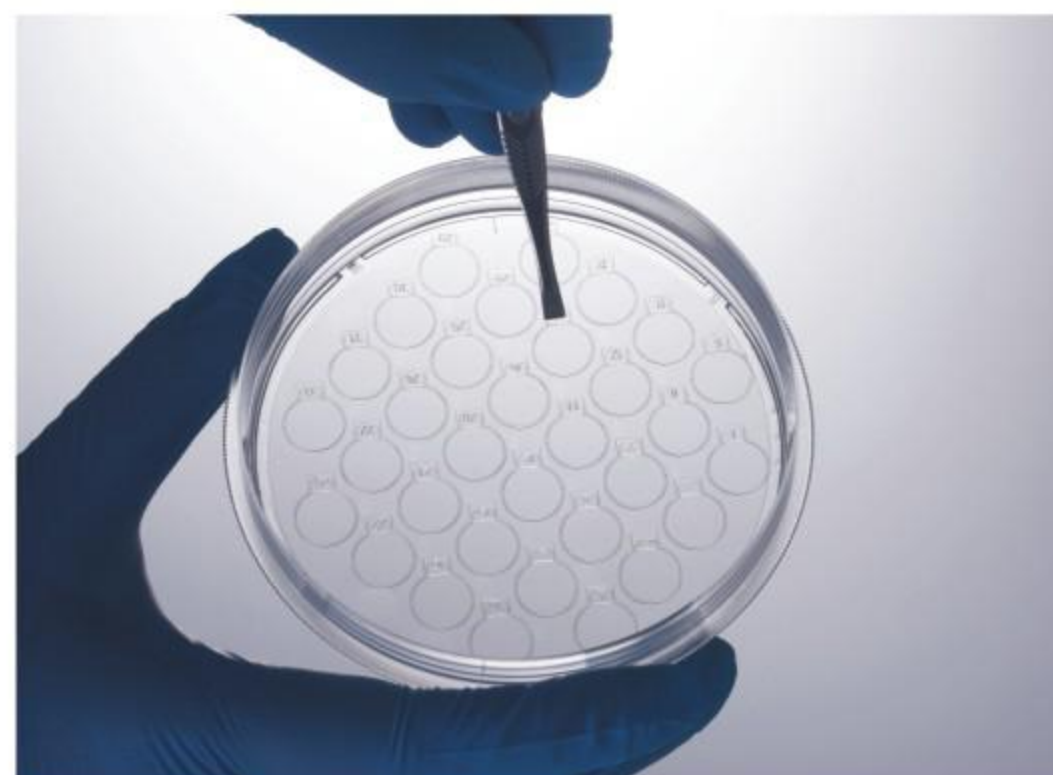

### Easy to Use



Cat.No	Dish(cm)	Cell slide Qty.	Diameter(mm)	Description Appro.Cell Growth Area(cm²) Single	Appro.Cell Growth Area(cm²) Total	Corresponding Plate	Qty.per bag/case
CXD206008		18	8	0.50	9.00	48	
CXD206010	6	12	10	0.79	9.42	48	1/48
CXD310008		45	8	0.50	22.50	48	
CXD310010	10	32	10	0.79	25.12	48	1/24

### Confocal Dish

- \* Available with 2 different glass bottom sizes of 15mm and 20mm
- \* Glass thickness: 0.12-0.16mm
- \* Borosilicate glasses is with high homogeneity, low bubble and inclusion content
- \* Medical grade shadowless glue, highly transparent achromatic
- \* Suitable for fluorescent microscope experiments, confocal microscopy and phase-contrast microscopic experiments, etc
- \* Dish surface is smooth and free from striation to maximize usable area for growth
- \* The rim on upper side of the lid mates with the dish brim for easy and secure stack
- \* Lids with several little chimbs to shape vents are available for very effective gas exchange
- \* Sterilized by gamma irradiation
- \* Non-pyrogenic

Cat.No	Pore Diameter(mm)	Surface Type	Sterile	Qty. per bag/case
BDD011035	15	Standard, Surface treated	Y	10/240
BDD012035	20	General, Non-treated	Y	10/240
BDD001035	15	General, Non-treated	Y	10/240
BDD002035	20	General, Non-treated	Y	10/240



### Cover Glass

Cat.No	Pore Diameter(mm)	Sterile	Qty.per bag/case
BDC000015	15	Y	100
BDC000020	20	Y	100

## CellIDETA™ Temperature-Responsive Cell Culture Surface

Thank you for using a product with temperature-responsive culture surface. The temperature-sensitive polymer with thickness of 15-20 nanometer chemically covalently immobilized on the culture surface. Cells can be spontaneously intactly detached from temperature-responsive culture surface around 20-25°C without enzymatic processing which is well known for its disfunction of cells. Keeping their activities is possible with temperature-responsive culture surface for cell culture.

### Applications

Ideal product for intactly harvesting cells, especially for fragile cells such as stem cells and neuron cells, and macrophage cells etc., and also for tissue culture, extra cellular matrix research, and so on.

### Cautions

- \* Please ensure that there is no damage to the package and read the following instructions carefully to ensure the maximum performance of this product .
- \* The product is intended for research purposes only. Any other use is not warranted by Jet coporation. Do not use the product for clinical or diagnostic purposes. Products with temperature-responsive surface are intended for single-use only
- \* Do not re-use the product as cell secreted and medium-derived components may be adsorbed to the surface after cell harvest, compromising performance in repeated use
- \* Re-sterilization and scratching of the culture surface may compromise the temperature-responsive surface properties

### In vitro cell culture

- \* The temperature-responsive polymer chemically covalently grafted to the culture surface area becomes slightly hydrophobic above 32°C, allowing cells to adhere. So it is recommended that cells are preferable incubated at 37°C
- \* The temperature-responsive surface becomes hydrophilic below 32°C, causing cell detachment from the surface
- \* To avoid undesired cell detachment during seeding cells and medium changes, pre-warming culture surface and culture medium (37°C) to facilitate cell attachment is suggested. Observations under a microscope should also be kept short in order to prevent cooling and undesired cell detachment. Seed cells evenly over the culture area to avoid uneven distribution of the cells in culture
- \* Attachment time for cells may vary with cell type
- \* Should you have difficulty in attaching cells, pre-coating of the culture surface with collagen, fibronectin, polylysine, laminin or the use of medium with serum may ease cell attachment

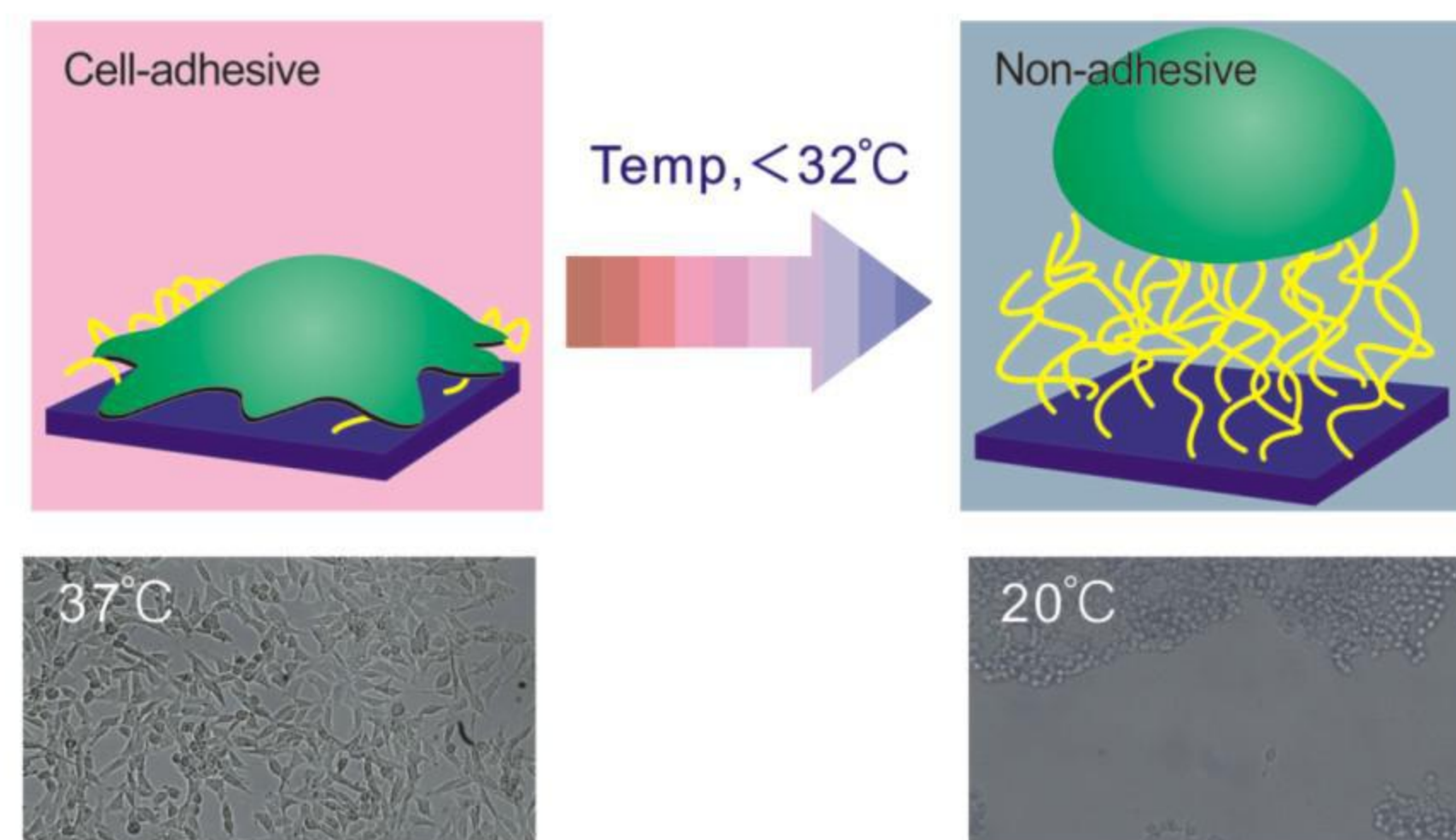

### Cells harvest

- \* Culture cells on temperature-responsive surface to a density before confluence, that is cell-cell junctions are not established, cells harvest are readily conducted by slight agitation and pipetting
- \* Place the product with temperature-responsive surface in an environment set at 20-25°C in order to detach the cells. Alternatively, the product may be placed at room temperature (20-25°C) under sterile conditions. For quicker cell detachment, the culture medium can be exchanged to 20-25°C culture medium prior to detachment
- \* Cells should detach spontaneously under pipetting with transfer pipettes or serological pipettes after keeping at 20-25°C within 15-30 minutes, some cells may not detach completely, depending on the cell type. The product with temperature-responsive surface becomes more hydrophilicity with decreasing the temperature of culture environment, resulting in more easily detaching of cells from temperature-responsive surface
- \* Normally the longer time required to harvest cells by conventional enzymatic processing, the stronger the cell attaching ability. Cells with stronger attaching ability that fail to detach spontaneously from temperature-responsive surface by slight pipetting can be detached by stronger pipetting or gently flushing the surface with medium after culturing at much lower temperature for longer time ( for example, at 4°C for 60 minutes )

### Storage

The product should be stored at room temperature (20-30°C) and out of direct sunlight.

### Disposal

Ensure the used product without biological and chemical pollution to the environment and disposed as recyclable plastics. The product is prepared and shipped under high quality control. However, should you have any claims or questions, please contact us for free.



### CellIDETA™ Cell and Tissue Culture Flasks

Cat.No	Volume(ml)	Surface Type	Sterile	Cell Growth Area(cm <sup>2</sup> )	Qty.per bag/case
CDF022250	250	CellIDETA™ Temperature-Responsive Culture Surface	Y	75.0	1/100

# CellATTACH® Surface Products

The CellATTACH® surface treatment is a latest technology which invented by JET's R&D team. This super hydrophilic surface offers a significant advantage over traditional cell culture surface. CellATTACH® surface treatment can improve cell spreading and attachment, is suitable for the cells that may adhere poorly due to cell phenotype, stressful culture conditions or those which normally require additional biological coatings for attachment.

## CellATTACH® Cell and Tissue Culture Flasks

- Available with 5 different growth areas of 12.5cm<sup>2</sup>, 25cm<sup>2</sup>, 75cm<sup>2</sup>, 182cm<sup>2</sup>, 300cm<sup>2</sup>
- CellATTACH® Surface Treated
- Flasks surface is flat and free from striation to maximize usable growth area
- 2 different cap styles can be used in both open and closed systems
- Innovative angled neck design offers good pipet and cell scraper access in
- Upper triangular and wider base shape provides stability
- Protrudent ridge on the back side of the flask makes it easy for stacking
- Special area near the neck for easy mark writing
- Both flask sides have engraved graduation
- Strict integrity tested
- Sterilized by gamma irradiation
- DNase/ RNase-free & Non-pyrogenic

Cat.No	Volume(ml)	Surface Type	Appro.Cell Growth Area(cm <sup>2</sup> )	Cap Styles	Sterile	Qty.per bag/case
CAF011025	25	CellATTACH® Surface Treated	12.5	Standard	Y	10/200
CAF012025	25		Vent	Y	10/200	
CAF011050	50		Standard	Y	10/200	
CAF012050	50		Vent	Y	10/200	
CAF011250	250		Standard	Y	5/100	
CAF012250	250		Vent	Y	5/100	
CAF011600	600		Standard	Y	5/40	
CAF012600	600		Vent	Y	5/40	
CAF011850	850		Standard	Y	3/18	
CAF012850	850		Vent	Y	3/18	

## CellATTACH® Cell and Tissue Culture Plates

- Available with 6 different growth surface areas of 6, 12, 24, 48, 96 and 96U wells
- CellATTACH® Surface Treated
- Uniform well volume ensures equal growth surface area
- Flat well bottom and round bottom plate
- Well surface is smooth and free from striation to maximize usable growth area
- Raised rims on wells with the uniform rings on the lid to reduce evaporation
- Single position lid reduces the risks of cross-contamination and the handling mistakes
- Wells are labeled with alphanumeric code for easy identification
- Suitable for all common instruments and automation
- Sterilized by gamma irradiation
- DNase/ RNase-free & Non-pyrogenic

Cat.No	Well Qty.	Bottom	Surface Type	Cell Growth Area(cm <sup>2</sup> )	Qty.per bag/case
CAP011006	6	Flat	CellATTACH® Surface Treated	1.90-2.90	1/100
CAP011012	12	Flat		0.76-1.14	1/100
CAP011024	24	Flat		0.38-0.57	1/100
CAP011048	48	Flat		0.19-0.29	1/100
CAP011096	96	Flat		0.075-0.20	1/100
CAP012096	96	U		0.1-0.2	1/100

## CellATTACH® Cell and Tissue Culture Dishes



- Available with 6 different diameters of 3.5cm, 6.0cm, 7.0cm, 9.0cm, 10.0cm and 15.0cm
- CellATTACH® Surface Treated
- Flat bottom uniform wall thickness ensures distortion-free bottom
- The rim on bottom side of the lid mates with the dish brim for easy and secure stack
- Lids with several little chimbs to shape vents are available for very effective gas exchange
- Numeric Scale 12, 3, 6, 9 divides dish into quadrants for easy orientation
- DNase/ RNase-free & Non-pyrogenic

Cat.No	Diameter(mm)	Surface Type	Cell Growth Area(cm <sup>2</sup> )	Sterile	Qty.per bag/case
CAD010035	35	CellATTACH® Surface Treated	8.5	Y	10/240
CAD010060	60		21.2	Y	10/240
CAD010070	70		36.3	Y	10/240
CAD010090	90		58.4	Y	10/240
CAD010100	100		60.8	Y	10/240
CAD010150	150		143.0	Y	5/80

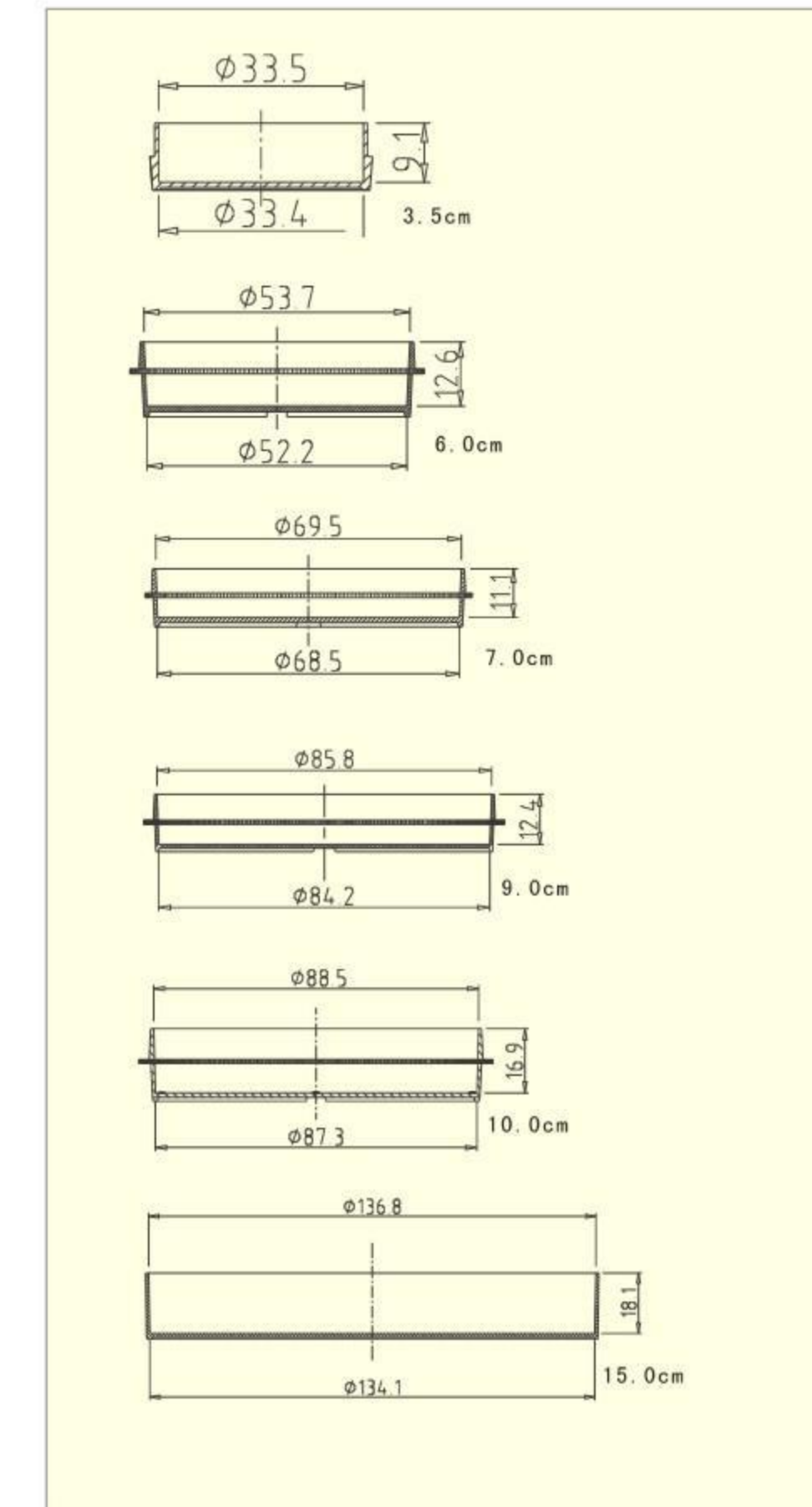
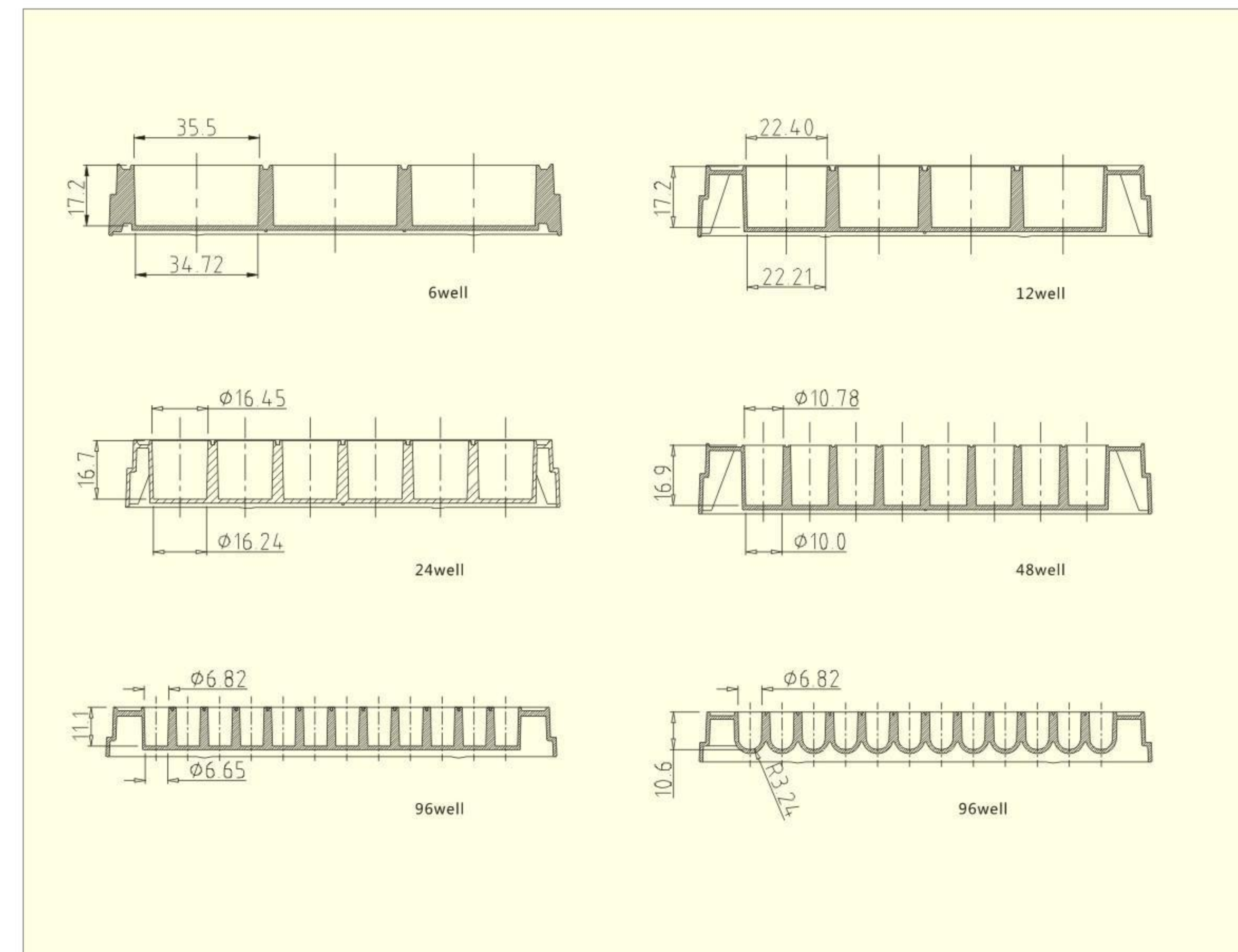

# Cell and Tissue Culture Products



## Cell and Tissue Culture Plates

Cell and Tissue Culture Plates are ideal for cell growth and cell yields on multiple, compare and other analyse.

- ★ Available with 8 different growth surface areas of 4, 6, 12, 24, 48, 96, 96U, 384 wells
- ★ Available in surface-treated or non-treated
- ★ Uniform well volume ensures equal growth surface area
- ★ Flat well bottom and round bottom plate
- ★ Well surface is smooth and free from striation to maximize usable growth area
- ★ Raised rims on wells with the uniform rings on the lid to reduce evaporation
- ★ Single position lid reduces the risks of cross-contamination and the handling mistakes
- ★ Wells are labeled with alphanumeric code for easy identification
- ★ Suitable for all common instruments and automation
- ★ Sterilized by gamma irradiation
- ★ DNase/RNase-free & Non-pyrogenic

### Order Information

- ★ Individually packaged in peel-to-open paper/plastic blister pack
- ★ Every case has printed with lot No. for quality traceability



Cat.No	Well Qty.	Surface Type	Max Well Volume(ml)[single well]	Lid	Sterile	Qty.per bag/case
TCP001004	4	General, Non-treated	1.50	Y	Y	1/100
TCP001006	6		17.0	Y	Y	1/100
TCP001012	12		6.80	Y	Y	1/100
TCP001024	24		3.50	Y	Y	1/100
TCP001048	48		1.55	Y	Y	1/100
TCP001096	96		0.39	Y	Y	1/100
TCP002096	96		0.32	Y	Y	1/100
TCP001384	384		0.14	Y	Y	1/100



Cat.No	Well Qty.	Surface Type	Max Well Volume(ml)[single well]	Cell Growth Area(cm <sup>2</sup> )[single well]	Lid	Sterile	Qty.per bag/case
TCP011004	4	Standard, surface treated	1.50	1.86-1.96	Y	Y	1/100
TCP011006	6		17.0	1.90-2.90	Y	Y	1/100
TCP011012	12		6.80	0.76-1.14	Y	Y	1/100
TCP011024	24		3.50	0.38-0.57	Y	Y	1/100
TCP011048	48		1.55	0.19-0.29	Y	Y	1/100
TCP011096	96		0.39	0.075-0.20	Y	Y	1/100
TCP012096	96U		0.32	0.32-0.38	Y	Y	1/100
TCP011384	384		0.14	0.10-0.11	Y	Y	1/100

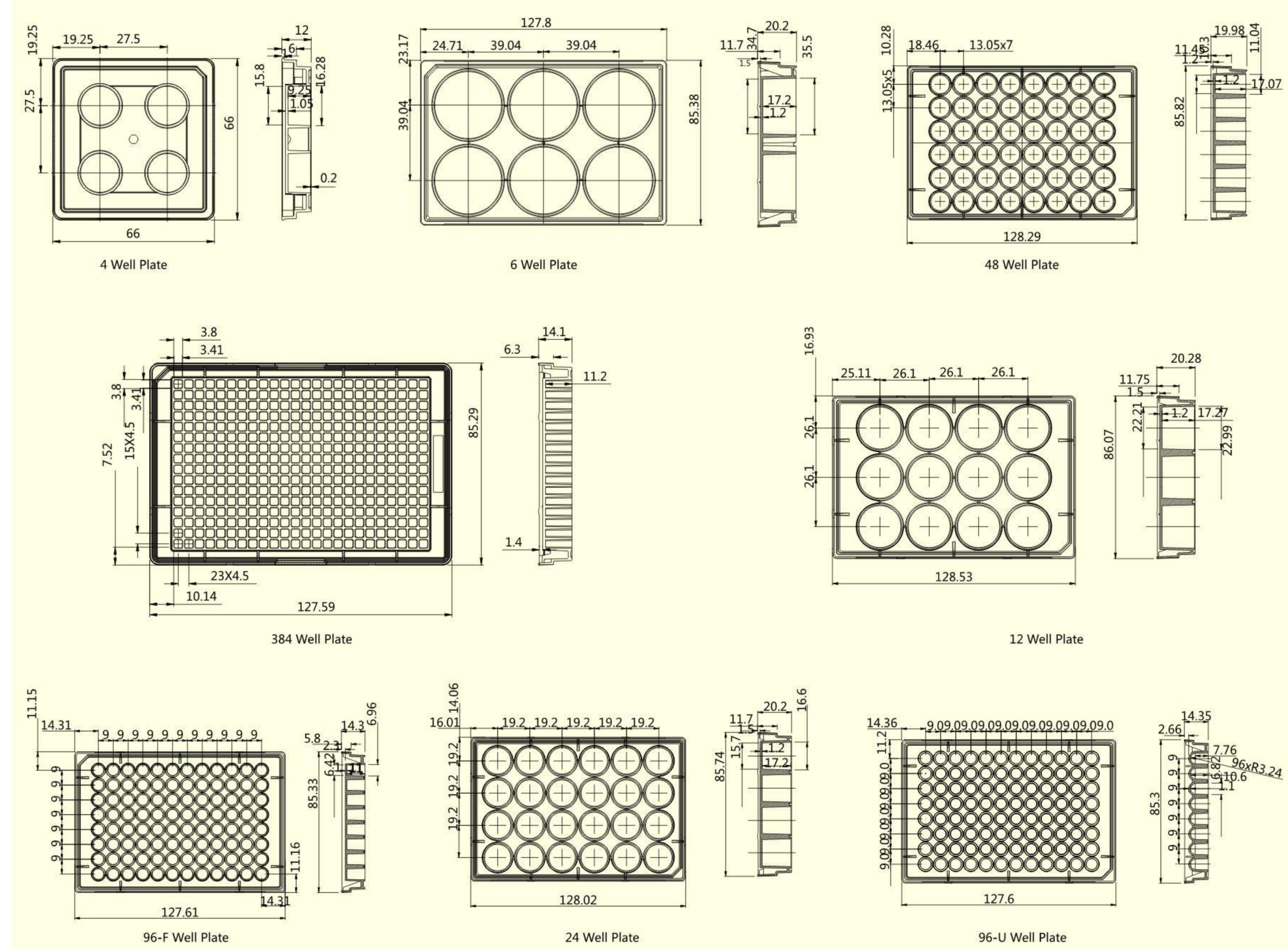

### Polycarbonate (PC) Membrane Tissue Culture Plate Inserts

\* The polycarbonate plate inserts feature a thin, semitransparent polycarbonate membrane that is available in six pore sizes from 0.1µm to 12.0µm. All inserts are treated for optimal cell attachment. The polycarbonate plate.

\* Inserts are sterile and assembled with well plates and resist most fixing and staining agents. All plates come with lids.



Cat.No	Well	Pore Size(µm)	Growth area for Insert membrane(cm <sup>2</sup> )	Sterilize	Qty.per bag/case
TCS000006	6	0.1	4.67	Y	6/24
TCS001006	6	0.4	4.67	Y	6/24
TCS005006	6	1.0	4.67	Y	6/24
TCS002006	6	3.0	4.67	Y	6/24
TCS003006	6	8.0	4.67	Y	6/24
TCS100006	6	12.0	4.67	Y	12/48
TCS000012	12	0.1	1.12	Y	12/48
TCS010012	12	0.4	1.12	Y	12/48
TCS005012	12	1.0	1.12	Y	12/48
TCS020012	12	3.0	1.12	Y	12/48
TCS030012	12	8.0	1.12	Y	12/48
TCS100012	12	12.0	1.12	Y	12/48
TCS000024	24	0.1	0.33	Y	12/48
TCS001024	24	0.4	0.33	Y	12/48
TCS005024	24	1.0	0.33	Y	12/48
TCS002024	24	3.0	0.33	Y	12/48
TCS003024	24	8.0	0.33	Y	12/48
TCS100024	24	12.0	0.33	Y	12/48
TCS004024	24	5.0	0.33	Y	12/48

### Polyester (PET) Membrane Tissue Culture Plate Inserts

Tissue Culture Plate Inserts feature a thin, microscopically transparent polyester membrane that is tissue culture treated for optimal cell attachment and growth. Tissue Culture Plate Inserts provide excellent cell visibility under phase contrast microscopy and allow assessment of cell viability and monolayer formation. Tissue Culture Plate Inserts are sterile and can be assembled with 6, 12 and 24 well plates. All plates come with lids.



Cat.No	Well	Pore Size(µm)	Growth area for Insert membrane(cm <sup>2</sup> )	Sterilize	Qty.per bag/case
TCS010006	6	0.1	4.67	Y	6/24
TCS011006	6	0.4	4.67	Y	6/24
TCS015006	6	1.0	4.67	Y	6/24
TCS012006	6	3.0	4.67	Y	6/24
TCS013006	6	8.0	4.67	Y	6/24
TCS010012	12	0.1	1.12	Y	12/48
TCS011012	12	0.4	1.12	Y	12/48
TCS015012	12	1.0	1.12	Y	12/48
TCS012012	12	3.0	1.12	Y	12/48
TCS013012	12	8.0	1.12	Y	12/48
TCS010024	24	0.1	0.33	Y	12/48
TCS011024	24	0.4	0.33	Y	12/48
TCS015024	24	1.0	0.33	Y	12/48
TCS012024	24	3.0	0.33	Y	12/48
TCS013024	24	8.0	0.33	Y	12/48

### Cell Culture Inserts

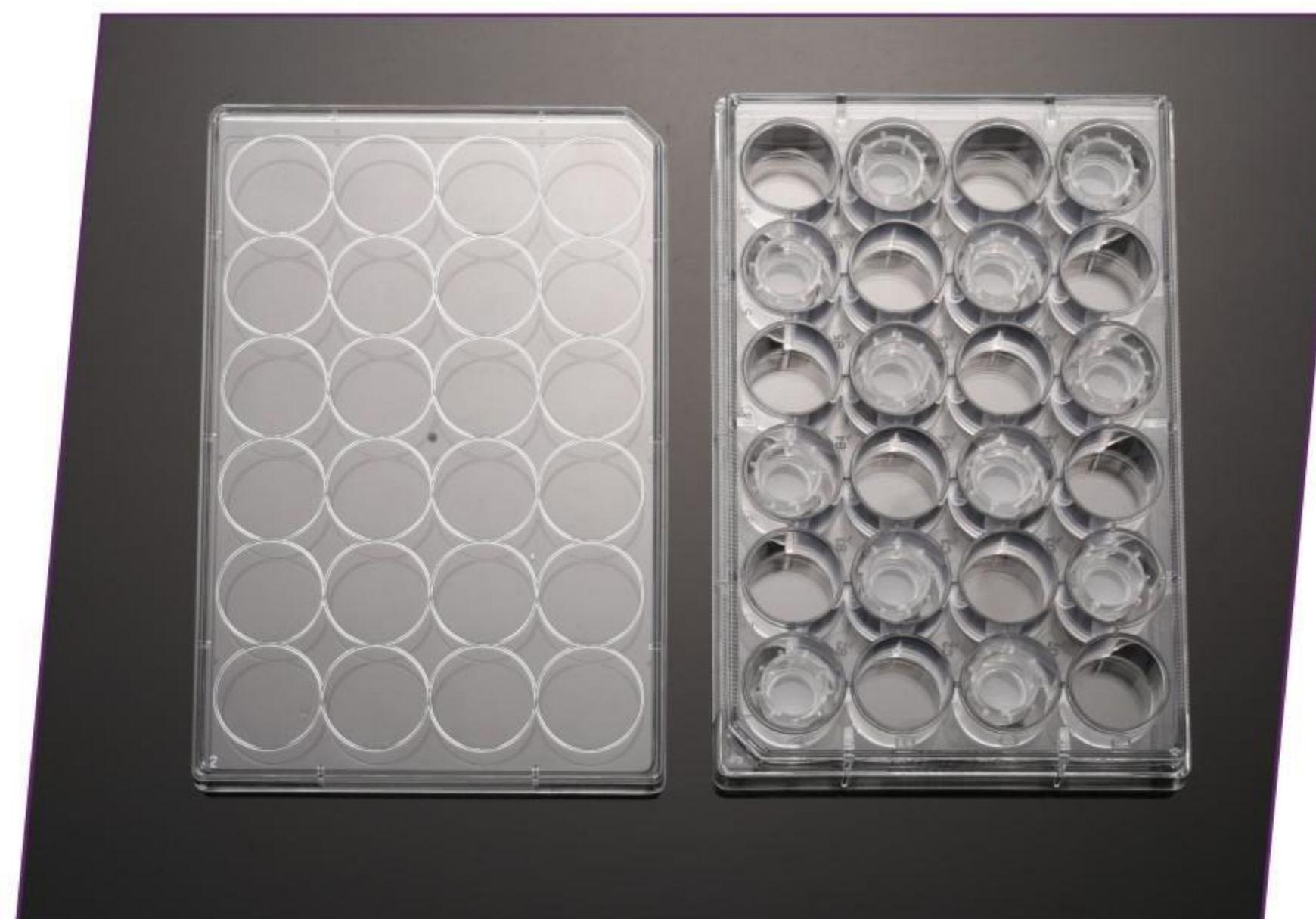

The surface of the cell culture insert is super hydrophilic and placed in a 24-well culture plate for ease of cell culture without the need for a matrix coating and can be optimized for 3-d cell imaging.

Our cell culture inserts and plates meet ANSI standards and are equipped with alphanumeric well identification; all items are USP Class VI, sterile and include lids.

### Application Examples

#### Transport studies

- \* Molecules including hormones and growth factors
- \* Drug transport across epithelial (Caca-2) and endothelial barriers
- \* Drug transport across brain microvascular endothelial cells

#### Co-cultivation studies

- \* Cell-cell interaction
- \* Cell-marix cell interaction
- \* Cell-substrate interaction

#### Tissue engineering

- \* Angiogenesis
- \* Dermal/epidermal and epithelial tissue models

Cat.No	Pore Size (µm)	Culture Area (cm) <sup>2</sup>	Suggested working Volume(ml)	No. insert/ multi -dishes	No. of multi-dishes/ case
TCS021024	0.4	0.47	1.1	24	4
TCS031024	3.0	0.47	1.1	24	4

## Cell and Tissue Culture Flasks

Cell and Tissue Culture Flasks are perfect for cell growth and cell yields aim on little and medium input volume

- \* Available with 5 different growth areas of 12.5cm<sup>2</sup>, 25cm<sup>2</sup>, 75cm<sup>2</sup>, 182cm<sup>2</sup>, 300cm<sup>2</sup>
- \* Available in surface-treated or Non-treated
- \* Flasks surface is flat and free from striation to maximize usable growth area
- \* 2 different cap styles can be used in both open and closed systems
- \* Innovative angled neck design offers good pipet and cell scraper access in
- \* Upper triangular and wider base shape provides stability
- \* Protrudent ridge on the back side of the flask makes it easy for stacking
- \* Special area near the neck for easy mark writing
- \* Both flask sides have engraved graduation
- \* Strict integrity tested
- \* Sterilized by gamma irradiation
- \* DNase/RNase-free and Non-pyrogenic

### Ordering Information

- \* Vacuum Package in durable zip resealable self-standing plastic bags that allow flasks to remain upright and reduce contamination
- \* Every package bag is labeled with lot number for quality traceability

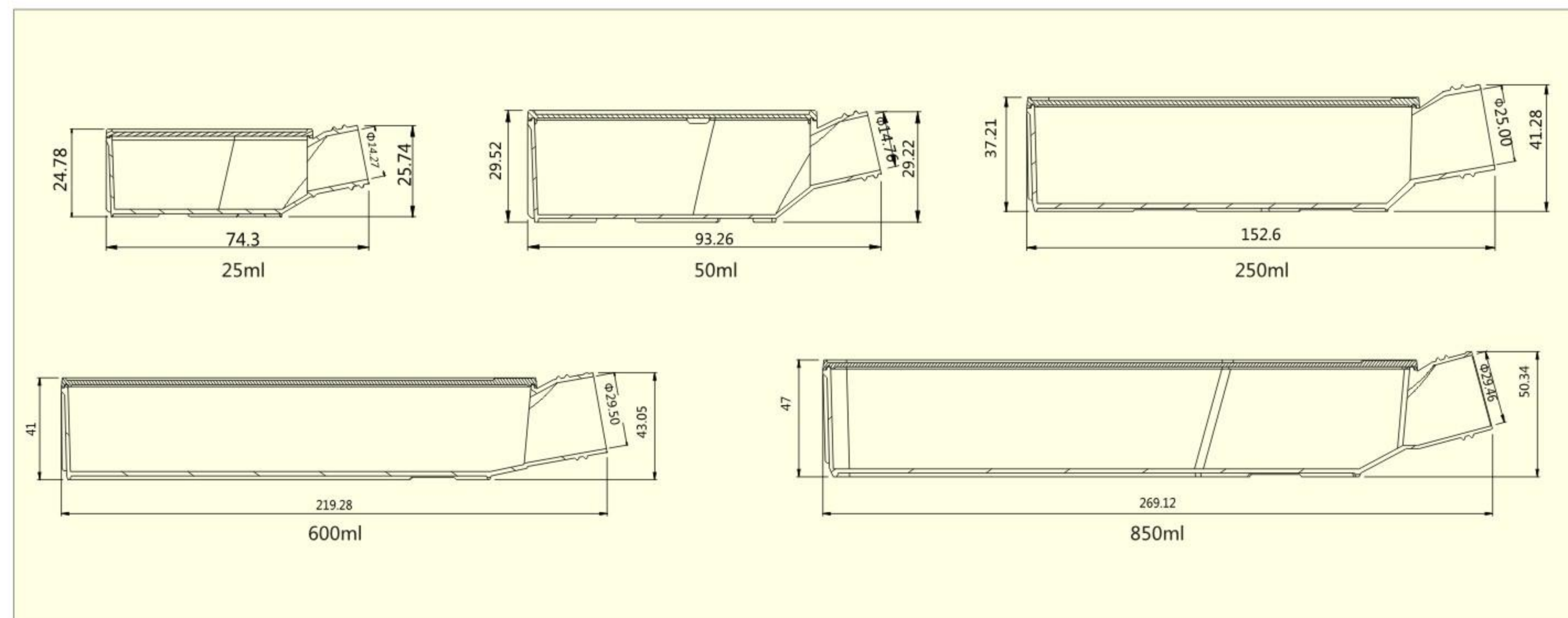

Cat.No	Volume(ml)	Surface Type	Working Volume(ml)	Cap Styles	Sterile	Qty.per bag/case
TCF001025	25	General, Non-treated	20	Standard	Y	10/200
TCF002025	25		Vent	Y	10/200	
TCF001050	50		Standard	Y	10/200	
TCF002050	50		Vent	Y	10/200	
TCF001250	250		Standard	Y	5/100	
TCF002250	250		Vent	Y	5/100	
TCF001600	600		Standard	Y	5/40	
TCF002600	600		Vent	Y	5/40	
TCF001850	850		Standard	Y	3/18	
TCF002850	850		Vent	Y	3/18	

Cat.No	Volume(ml)	Surface Type	Approx. Cell Growth Area(cm <sup>2</sup> )	Cap Styles	Sterile	Qty.per bag/case
TCF011025	25	Standard, Surface treated	12.5	Standard	Y	10/200
TCF012025	25		Vent	Y	10/200	
TCF011050	50		Standard	Y	10/200	
TCF012050	50		Vent	Y	10/200	
TCF011250	250		Standard	Y	5/100	
TCF012250	250		Vent	Y	5/100	
TCF011600	600		Standard	Y	5/40	
TCF012600	600		Vent	Y	5/40	
TCF011850	850		Standard	Y	3/18	
TCF012850	850		Vent	Y	3/18	

## 600ml Tissue Culture Extended Flasks

Cat.No	Volume(ml)	Surface Type	Working Volume(ml)	Cap Styles	Sterile	Qty. per bag/case
TCF101600	600	General, Non-treated	500	Standard	Y	5/40
TCF102600	600		Vent	Y	5/40	

Cat.No	Volume(ml)	Surface Type	Approx. Cell Growth Area(cm <sup>2</sup> )	Cap Styles	Sterile	Qty. per bag/case
TCF111600	600	Standard, Surface Treated	182.0	Standard	Y	5/40
TCF112600	600		Vent	Y	5/40	

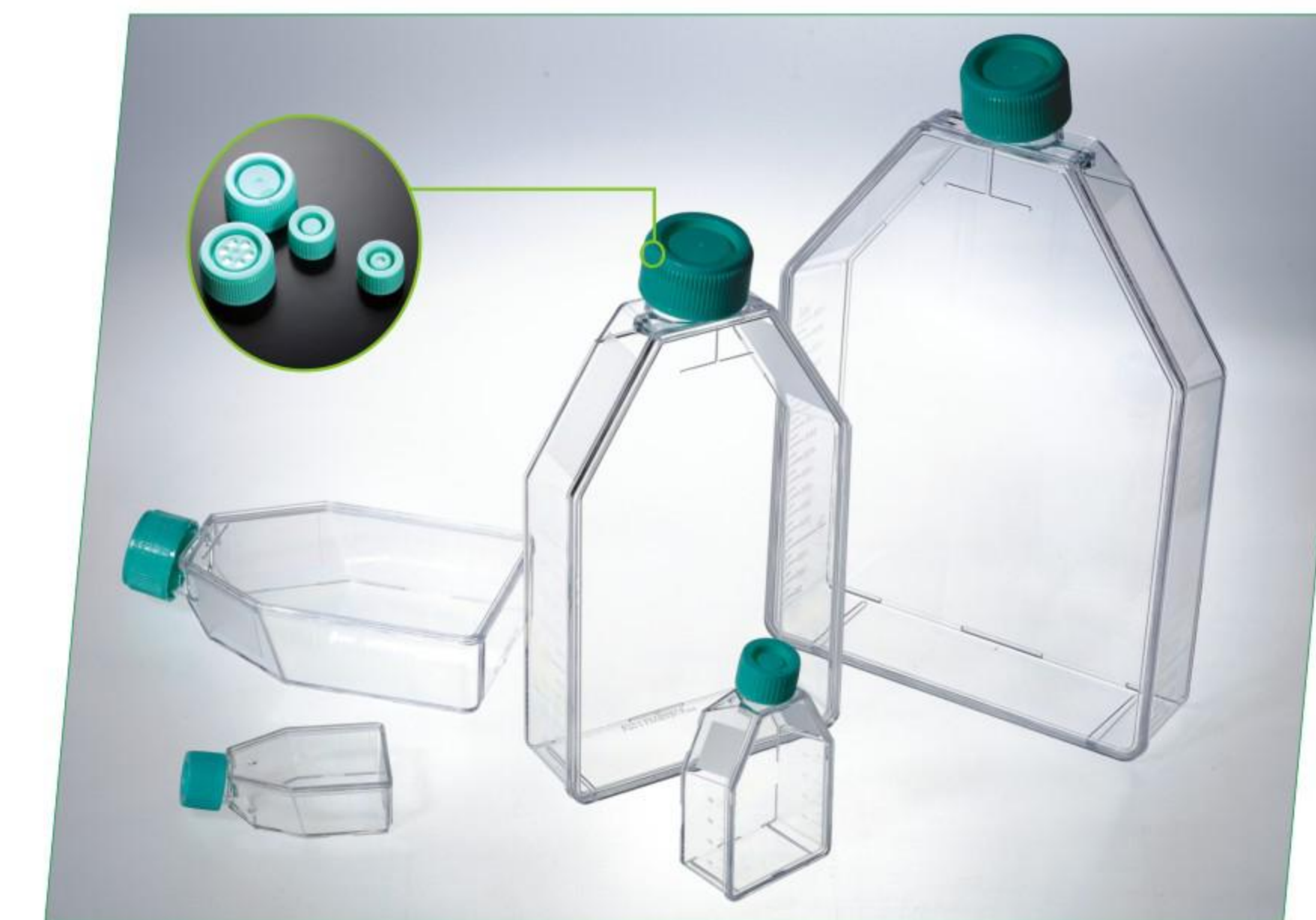

### Plug Sealing Caps:

Standard polyethylene caps can be used in closed systems, providing a liquid and gas sheer seal. But it can be simply unscrew the cap one quarter of a turn, this cap can also be used in open system.

### Vented Caps:

Vented polyethylene caps contain a 0.22µm hydrophobic filter to allow gas exchange and minimize risk of cross-contamination.



### Cell and Tissue Culture Dishes

Cell and Tissue Culture Dishes are ideal containers for cell growth and yields aim on little and medium input volume, and also useful in sample separation, pre-treatment, storage and so on.

- \* Available with 7 different diameters of 1.8, 3.5, 6.0, 7.0, 9.0, 10.0 and 15.0cm
- \* Available in surface-treated or non-treated
- \* Flat bottom uniform wall thickness ensures distortion-free bottom
- \* Dish surface is smooth and free from striation to maximize usable area for growth
- \* The rim on upper side of the lid mates with the dish brim for easy and secure stack
- \* Lids with several little chimbs to shape vents are available for very effective gas exchange
- \* Sterilized by gamma irradiation
- \* Non-pyrogenic

#### Order Information

- \* Package in durable zip resealable self-standing plastic bags that allow dishes to remain upright and reduce contamination
- \* Every package bag is labeled with lot number for quality traceability

Cat.No	Diameter(mm)	Surface Type	Dimension(mm)	Appro.Cell Growth Area(cm <sup>2</sup> )	Lid	Sterile	Qty.per bag/case	
TCD000018	18	General Non-treated	12.1×17.8	12.0	Y	Y	10/600	
TCD000035	32.8		12.5×37.8	8.5	Y	Y	10/960	
TCD000060	52.0		17.8×58.8	21.2	Y	Y	10/600	
TCD000070	68.0		15.0×73.5	36.3	Y	Y	10/600	
TCD000090	84.6		17.0×91.5	55.0	Y	Y	10/500	
TCD000100	87.8		22.0×95.6	60.8	Y	Y	10/300	
TCD000150	135.5		21.9×143	143.0	Y	Y	1/120	
TCD001150	135.5		21.9×143	143.0	Y	Y	5/100	
TCD010018	18		Standard Surface treated	12.1×17.8	12.0	Y	Y	10/600
TCD010035	32.8			12.5×37.8	8.5	Y	Y	10/960
TCD010060	52.0	17.8×58.8		21.2	Y	Y	10/600	
TCD010070	68.0	15.0×73.5		36.3	Y	Y	10/600	
TCD010090	84.6	17.0×91.5		55.0	Y	Y	10/500	
TCD010100	87.8	22.0×95.6		60.8	Y	Y	10/300	
TCD010150	135.5	21.9×143		143.0	Y	Y	1/120	
TCD050150	135.5	21.9×143		143.0	Y	Y	5/100	

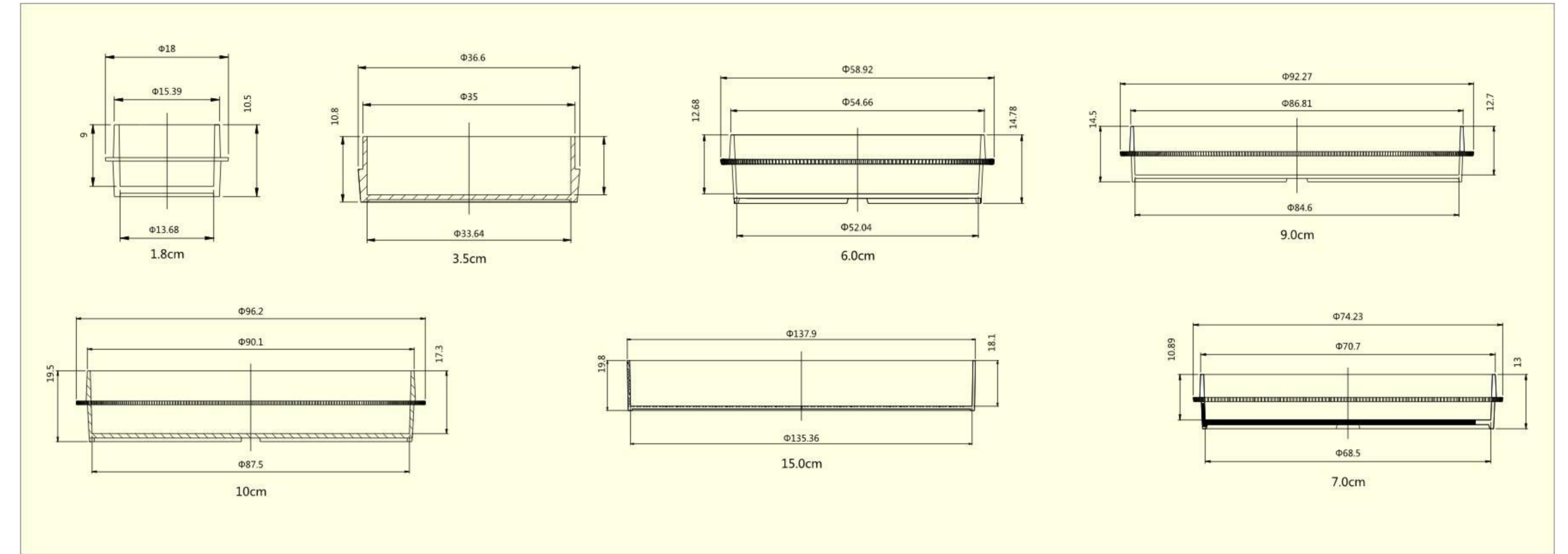

### 6cm Cell and Tissue Culture Center-well Dish

- \* Available in surface treated or non-treated
- \* Cell growth area of center well is 3.35 cm<sup>2</sup>
- \* Dish surface is smooth and free from striation to maximize usable area for growth
- \* The rim on upper side of the lid mates with the dish brim for easy and secure stack
- \* Lids with several little chimbs to shape vents are available for very effective gas exchange
- \* Sterilized by gamma irradiation
- \* Non-pyrogenic and DNase/RNase-free

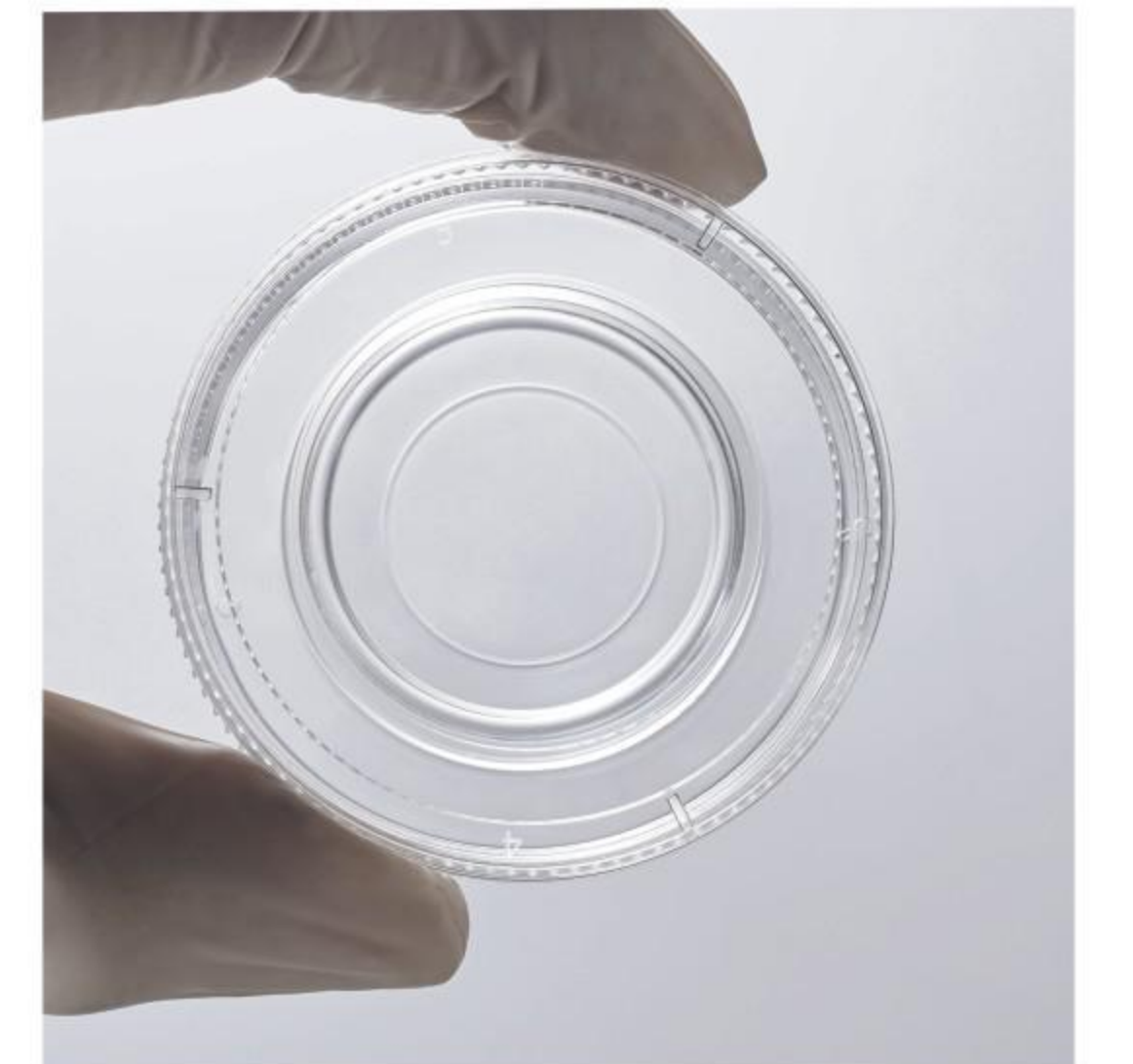

Cat.No	Diameter(mm)	Surface Type	Dimension(mm)	Appro. Cell Growth Area (cm <sup>2</sup> )	Lid	Sterile	Qty. per bag/case
TCD100060	54.7	General, Non-treated	13.9*54.7	3.35	Y	Y	10/600
TCD110060	54.7	Standard, Surface Treated	13.9*54.7	3.35	Y	Y	10/600

### L-shaped Cell Spreader

- \* Disposable green L-shaped cell spreaders are ideal for spreading cell or bacterial cultures evenly
- \* The L-shaped allows application on the entire dish or plate surface
- \* Smooth spreading surface with slight upward return reduces the risk of damaging agar sample
- \* Spreaders are manufactured of polypropylene and pre-sterilized, eliminating the need for flaming or autoclaving
- \* Sterilized by gamma irradiation
- \* Individually wrapped and bulk packaging
- \* Non-pyrogenic

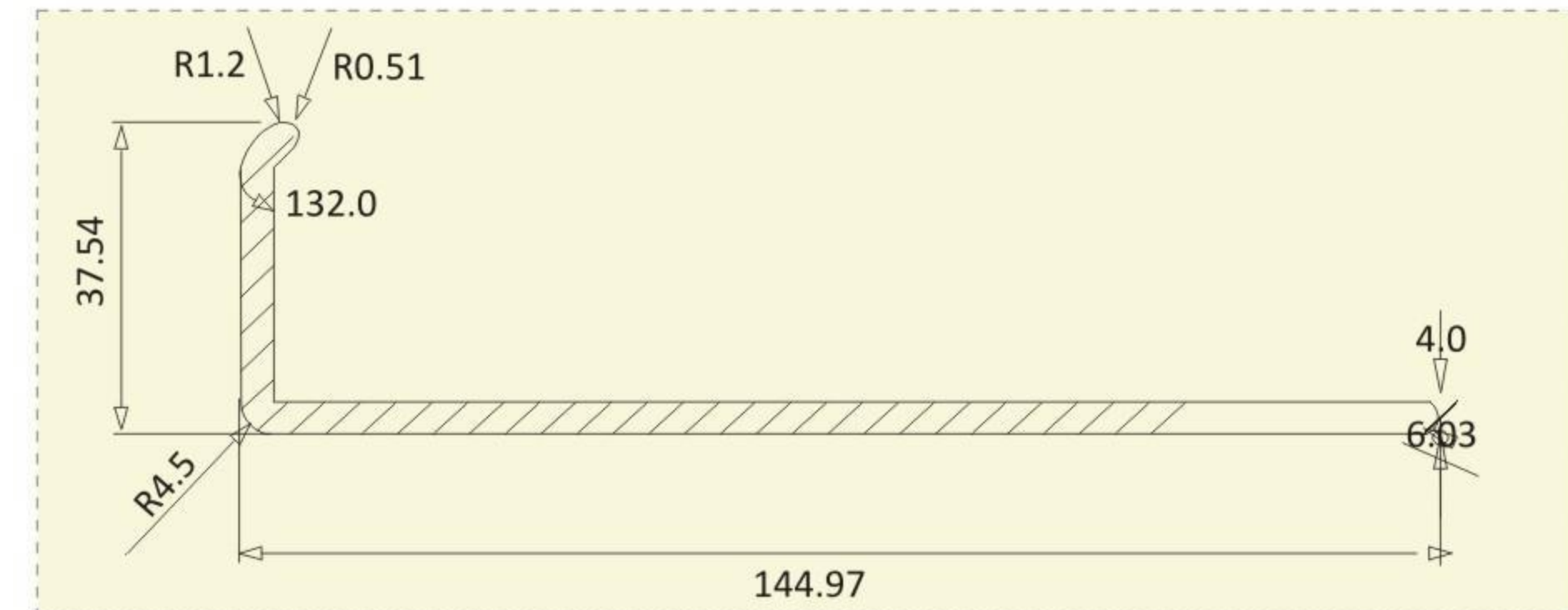

Cat.No	Description	Sterile	Qty./case
CSP011014	PP	Y	1/100
CSP012014	PP	Y	10/500

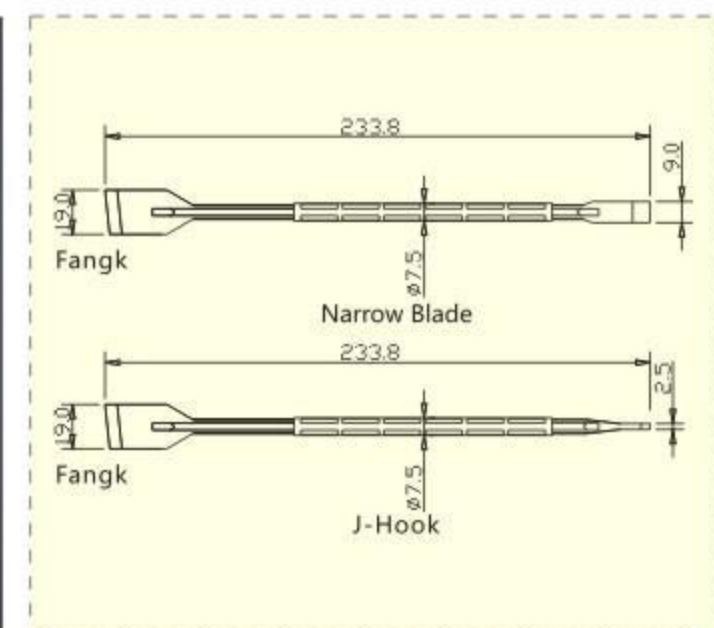
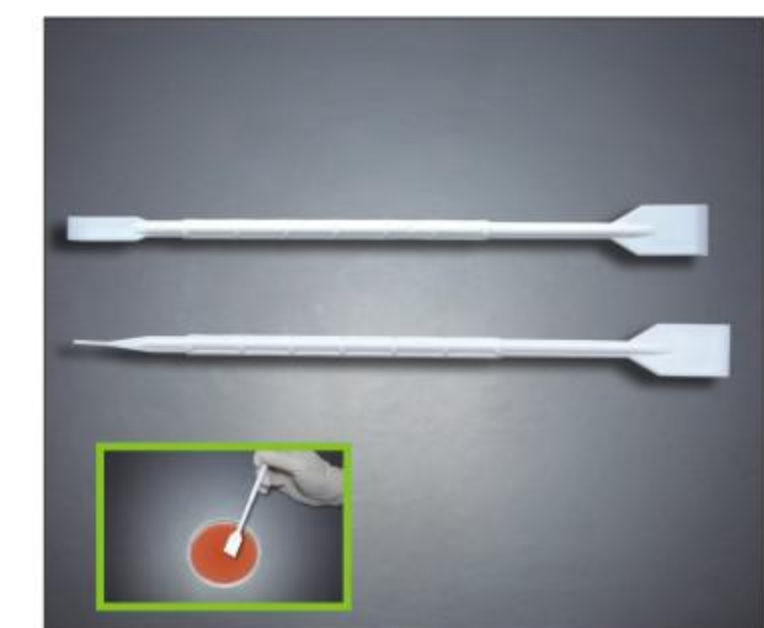

### Flat Blade Cell Lifter

Flat Blade Cell Lifter is manufactured with exclusively high-grade polyethylene(PE) which is tensile to make sure the manual harvesting of cells well.

- \* Available with 2 different styles of 9.0mm Narrow Blade and 2.5mm J-Hook
- \* Convenient operation, special blade design minimizes cell damage
- \* Individually wrapped
- \* Sterilized by gamma irradiation
- \* DNase/RNase-free and Non-pyrogenic

Cat.No	Total Length(cm)	Blade Length(mm)	Material	Blade Position	Sterile	Qty.per bag/case
CSC012023	23.4	9.0	PE	J-Hook	Y	1/100
CSC011023	23.4	2.5	PE	Narrow Blade	Y	1/100

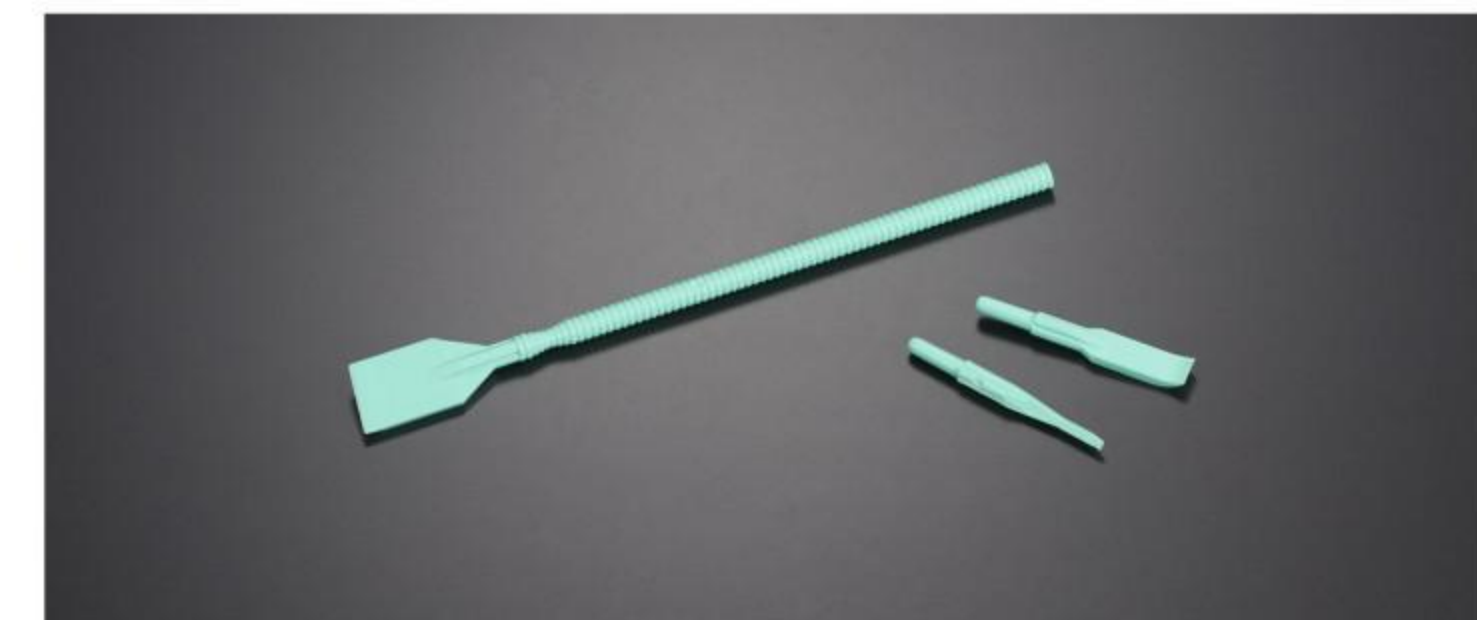

### Exchangeable Cell Blade and Lifter

Cat.No	Description	Sterile	Qty. per bag/case
CSC013001	Light Green, 9.0 mm J-Hook	Y	1/100
CSC013002	Light Green, 2.5mm Narrow Blade	Y	1/100



### Cell Strainers

Cell strainers are manufactured from a strong nylon mesh with evenly spaced mesh pores and gamma resistant. These cell strainers are sterile, rapid, easy-to-use devices for isolating primary cells to consistently obtain a uniform single-cell suspension from tissues. Protect your valuable flow cytometry and cell sorting instrumentation by reliably removing clumps and debris from cell suspensions and clinical samples prior to analysis.

- \* Available in 3 mesh sizes, 40µm, 70µm, and 100µm
- \* 3 different colors: blue, white, and yellow, for easy identification
- \* Improved uniformity of single cell suspensions
- \* Made of a strong nylon mesh with evenly spaced mesh pores
- \* The extended lip on the strainer enables aseptic handling with forceps
- \* Design to fit perfectly into a JET 50ml conical tube
- \* Ready-to-use, sterilized by gamma irradiation
- \* Individually packaged
- \* DNase & RNase-free
- \* Non-pyrogenic

#### Order Information

- \* Single package in easy-to-open bag to assure contamination-free
- \* Every case has printed lot No. for quality traceability

Cat.No	Capacity(µl)	Color	Sterile	Qty. per bag/case
CSS013040	40	Blue	Y	50/200
CSS013070	70	White	Y	50/200
CSS013100	100	Yellow	Y	50/200



### Pestles for Cell Strainer

- \* Using PP materials, high hardness, wear resistance
- \* A mesh bottom line, grinding better
- \* Handle special process design, non-slip and easy grip
- \* And supporting the use of cell strainer, reduce sample loss
- \* Non-pyrogenic and certified DNase/RNase-free

#### Order Information

- \* Easy to tear the paper and plastic individually packaged, easy to open use
- \* Use with anti-press 200 pounds, high-quality packaging cartons, better protection of the product
- \* Each package is printed with lot number, to facilitate quality tracking

Cat.No	Volume(ml)	Colour	Material	Sterile	Qty.per bag/case
CSP001001	13.5	Fluorescent green	PP	Y	1/100



## Cell scrapers

- \* Available with 2 different lengths of 25cm, 2.0cm blade; 39cm, 3.0cm blade
- \* Two positions of blade: scraper and lifter
- \* Material: Blades/TPE; Handle/ABS
- \* Special developed to make the process of scraping off and collecting cells more easier and effective
- \* These particularly thin,swiveling, flexible blades are easy to use, cells from any damage
- \* Slender,tepid, easy to blow to them and collect cells
- \* Sterilized by Gamma irradiation
- \* Individually wrapped
- \* DNase/RNase-free & Non-pyrogenic

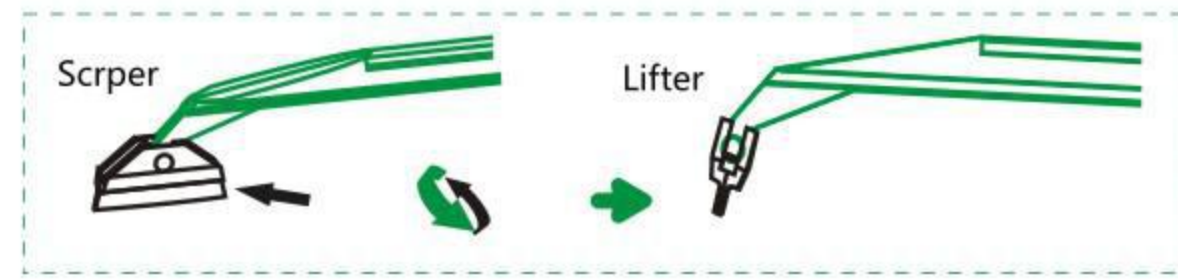

Cat.No	Blade(cm)	Total Length(cm)	Material	Blade Position	Sterile	Qty.per bag/case
CSC011025	2.0	25	Blades/TPE; Handle/ABS	Scraper	Y	1/100
CSC012025	2.0	25	Blades/TPE; Handle/ABS	Lifter	Y	1/100
CSC011039	3.0	39	Blades/TPE; Handle/ABS	Scraper	Y	1/100
CSC012039	3.0	39	Blades/TPE; Handle/ABS	Lifter	Y	1/100



## Rotatable™ Cell Scrapers

Changes of the blade angle of the Rotatable™ cell scraper require slight pressure on the handle using the forfinger, thus pushing the handle downward towards the floor of the container.

- \* Available with 2 different lengths of 23cm, 30cm
- \* Material: blades/PE, handle/ABS
- \* Free rotating blade to twist to the desired direction
- \* Total access to all corner
- \* Small raised knobs on the handle
- \* Individually wrapped
- \* Sterilized by gamma irradiation
- \* DNase/RNase-free & Non-pyogenic

### Order Information

- \* Available with individually wrapped in easy-to-open bag
- \* Every case has printed lot No.for quality traceability

Cat.No	Blade(cm)	Total Length(cm)	Material	Sterile	Qty.per bag/case
CSC211023	1.25	23	Blades/PE; Handle/ABS	Y	1/150
CSC211030	1.25	30	Blades/PE; Handle/ABS	Y	1/150
CSC212023	1.95	23	Blades/PE; Handle/ABS	Y	1/150
CSC212030	1.95	30	Blades/PE; Handle/ABS	Y	1/150

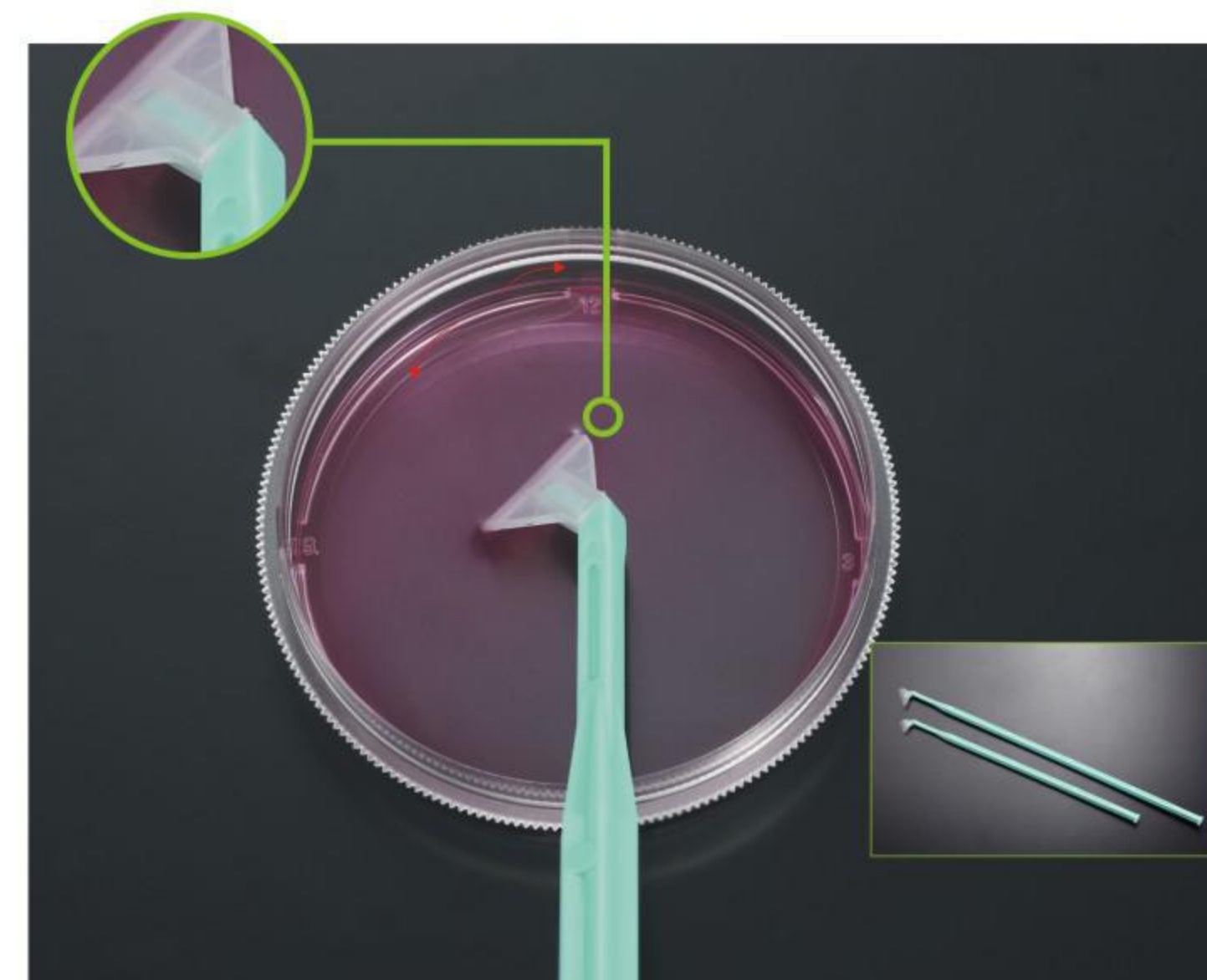

## Inoculating Loops and Needle

**Inoculating loops and needle are really useful tools in inoculating experiment.**

- \* Made from high quality polypropylene or polystyrene
- \* Available with 3 inoculating volumes of micro-quantity, 1μl, 10μl and needle
- \* Vacuum-gas plasma surface treated, allowing liquid or solid culture medium to attach
- \* Color-coded for easy identification
- \* Accurate sampling volume design ensure the uniform sample quantity
- \* The combination of heedle and loop is used in the dual function
- \* Long flexible stem can be bent to come through narrow or small volume tubes and dishes
- \* Available in gamma irradiation sterilized or non-sterilized

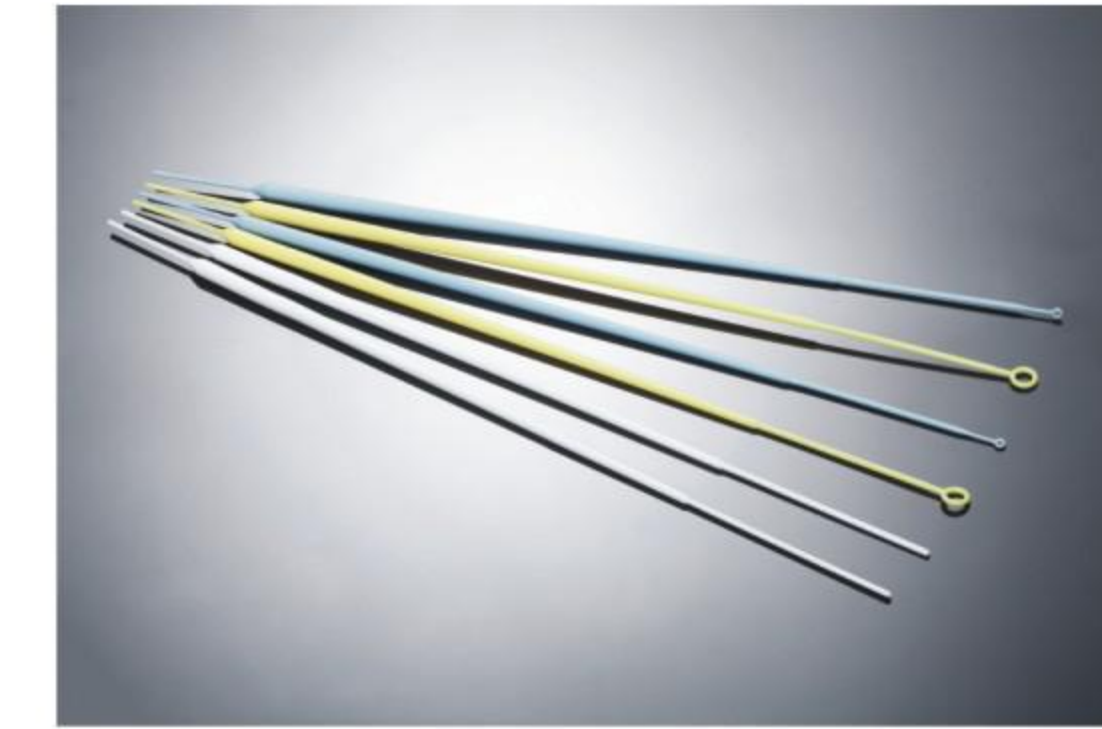

### Ordering Information

- \* Packaged in peel to open packs to assure contamination-free
- \* Every package case is printed with lot No. for quality traceability

Cat.No	Capacity(μl)	Material	Length(mm)	Color	Sterile	Qty. per bag/case
DIL101001	1.0	PS	228	Blue	Y	25/20
DIL212001	1.0	PS	228	Blue	Y	10/2000
DIL112001	1.0	PS	228	Blue	Y	1/3000
DIL211001	1.0	PS	228	Blue	Y	10/12000
DIL101010	10.0	PS	228	Yellow	Y	25/2000
DIL212010	10.0	PS	228	Yellow	Y	10/2000
DIL112010	10.0	PS	228	Yellow	Y	1/3000
DIL211010	10.0	PS	228	Yellow	Y	10/12000
DIL220001	-	PS	228	White	Y	25/2000
DIL223001	-	PS	228	White	Y	10/2000
DIL222001	-	PS	228	White	Y	1/3000
DIL221001	-	PS	228	White	Y	10/12000
DIL011001	1.0	PP	218	White	Y	20/2000
DIL010001	1.0	PP	218	White	N	20/2000
DIL011010	10.0	PP	221	Blue	Y	20/2000
DIL010010	10.0	PP	221	Blue	N	20/2000
DIL021001	-	PP	221	Yellow	Y	20/2000
DIL020001	-	PP	221	Yellow	N	20/2000

## Freezing Vials

Freezing Vials are manufactured from high quality polypropylene and gamma resistant.

Freezing Vials withstand low temperatures for safe storage and transportation of cells, blood, serum and other specimens. Freezing Vials are manufactured from high quality polypropylene and gamma resistant.

Freezing Vials withstand low temperatures for safe storage and transportation of cells,blood,serum and other specimens.

Cat.No	Volume(ml)	Bottom	Cap Color	Sterilize	Per bag/case
FCT611415	1.5	Conical	Yellow	N	50/5000
FCT611515	1.5	Conical	Green	N	50/5000
FCT611615	1.5	Conical	Pink	N	50/5000
FCT611715	1.5	Conical	Brown	N	50/5000
FCT611815	1.5	Conical	White	N	50/5000
FCT611915	1.5	Conical	Black	N	50/5000
FCT612015	1.5	Conical	Natural	Y	50/5000
FCT612115	1.5	Conical	Red	Y	50/5000
FCT612215	1.5	Conical	Orange	Y	50/5000
FCT612315	1.5	Conical	Bule	Y	50/5000
FCT612415	1.5	Conical	Yellow	Y	50/5000
FCT612515	1.5	Conical	Green	Y	50/5000
FCT612615	1.5	Conical	Pink	Y	50/5000
FCT612715	1.5	Conical	Brown	Y	50/5000
FCT612815	1.5	Conical	White	Y	50/5000
FCT612915	1.5	Conical	Black	Y	50/5000
FCT511020	2.0	Self-standing	Natural	N	20/5000
FCT511120	2.0	Self-standing	Red	N	20/5000
FCT511220	2.0	Self-standing	Orange	N	20/5000
FCT511320	2.0	Self-standing	Bule	N	20/5000
FCT511420	2.0	Self-standing	Yellow	N	20/5000
FCT511520	2.0	Self-standing	Green	N	20/5000
FCT511620	2.0	Self-standing	Pink	N	20/5000
FCT511720	2.0	Self-standing	Brown	N	20/5000
FCT511820	2.0	Self-standing	White	N	20/5000
FCT511920	2.0	Self-standing	Black	N	20/5000
FCT512020	2.0	Self-standing	Natural	Y	20/5000
FCT512120	2.0	Self-standing	Red	Y	20/5000

Cat.No	Volume(ml)	Bottom	Cap Color	Sterilize	Per bag/case
FCT512220	2.0	Self-standing	Orange	Y	20/5000
FCT512320	2.0	Self-standing	Bule	Y	20/5000
FCT512420	2.0	Self-standing	Yellow	Y	20/5000
FCT512520	2.0	Self-standing	Green	Y	20/5000
FCT512620	2.0	Self-standing	Pink	Y	20/5000
FCT512720	2.0	Self-standing	Brown	Y	20/5000
FCT512820	2.0	Self-standing	White	Y	20/5000
FCT512920	2.0	Self-standing	Black	Y	20/5000
FCT611020	2.0	Conical	Natural	N	20/5000
FCT611120	2.0	Conical	Red	N	20/5000
FCT611220	2.0	Conical	Orange	N	20/5000
FCT611320	2.0	Conical	Bule	N	20/5000
FCT611420	2.0	Conical	Yellow	N	20/5000
FCT611520	2.0	Conical	Green	N	20/5000
FCT611620	2.0	Conical	Pink	N	20/5000
FCT611720	2.0	Conical	Brown	N	20/5000
FCT611820	2.0	Conical	White	N	20/5000
FCT611920	2.0	Conical	Black	N	20/5000
FCT612020	2.0	Conical	Natural	Y	20/5000
FCT612120	2.0	Conical	Red	Y	20/5000
FCT612220	2.0	Conical	Orange	Y	20/5000
FCT612320	2.0	Conical	Bule	Y	20/5000
FCT612420	2.0	Conical	Yellow	Y	20/5000
FCT612520	2.0	Conical	Green	Y	20/5000
FCT612620	2.0	Conical	Pink	Y	20/5000
FCT612720	2.0	Conical	Brown	Y	20/5000
FCT612820	2.0	Conical	White	Y	20/5000
FCT612920	2.0	Conical	Black	Y	20/5000



## Freezing Vials

- \* Freezing Vials are your best choice for based on the high quality and special features
- \* Manufactured from durable PP and PE
- \* Available with 4 volumes: 0.5ml, 1.5ml, 2.0ml, 5.0ml
- \* Interlocking cap design ensure exact fit and will not absorb water or other contamination
- \* Part of the tube has mold engraved scale experimental process of recording easy
- \* Closures containing silicone gasket can avoid liquid leakage
- \* Screw cap for one-handed operation
- \* Temperature range: -196°C - 121°C
- \* Easy-to-read graduations are accurate to ±2%
- \* Sterilized by gamma radiation

Cat.No	Volume(ml)	Bottom	Sterile	Qty.per bag(box)/case
FCT010005	0.5	Conical	N	100/1000
FCT011005	0.5	Conical	Y	100/1000
FCT110005	0.5	Self-standing	N	100/1000
FCT111005	0.5	Self-standing	Y	100/1000
FCT210005	0.5	Conical	N	500/5000
FCT310005	0.5	Self-standing	N	500/5000
FCT010015	1.5	Conical	N	100/1000
FCT011015	1.5	Conical	Y	100/1000
FCT110015	1.5	Self-standing	N	100/1000
FCT111015	1.5	Self-standing	Y	100/1000
FCT210015	1.5	Conical	N	500/5000
FCT310015	1.5	Self-standing	N	500/5000
FCT010020	2.0	Conical	N	100/1000
FCT011020	2.0	Conical	Y	100/1000
FCT110020	2.0	Self-standing	N	100/1000
FCT111020	2.0	Self-standing	Y	100/1000
FCT210020	2.0	Conical	N	500/5000
FCT310020	2.0	Self-standing	N	500/5000
FCT001050	5.0	Self-standing	Y	50/2500

## Cap Lid for Freezing Vials

Cat.No	Color	Sterile	Qty.per bag/case
FTC000001	Natural	N	500/5000
FTC000002	White	N	500/5000
FTC000003	Green	N	500/5000
FTC000004	Blue	N	500/5000



Cat.No	Volume(ml)	Bottom	Cap color	Sterile	Per bag/case
FCT511005	0.5ml	Self-standing	Natural	N	50/5000
FCT511105	0.5ml	Self-standing	Red	N	50/5000
FCT511205	0.5ml	Self-standing	Orange	N	50/5000
FCT511305	0.5ml	Self-standing	Bule	N	50/5000
FCT511405	0.5ml	Self-standing	Yellow	N	50/5000
FCT511505	0.5ml	Self-standing	Green	N	50/5000
FCT511605	0.5ml	Self-standing	Pink	N	50/5000
FCT511705	0.5ml	Self-standing	Brown	N	50/5000
FCT511805	0.5ml	Self-standing	White	N	50/5000
FCT511905	0.5ml	Self-standing	Black	N	50/5000
FCT512005	0.5ml	Self-standing	Natural	Y	50/5000
FCT512105	0.5ml	Self-standing	Red	Y	50/5000
FCT512205	0.5ml	Self-standing	Orange	Y	50/5000
FCT512305	0.5ml	Self-standing	Bule	Y	50/5000
FCT512405	0.5ml	Self-standing	Yellow	Y	50/5000
FCT512505	0.5ml	Self-standing	Green	Y	50/5000
FCT512605	0.5ml	Self-standing	Pink	Y	50/5000
FCT512705	0.5ml	Self-standing	Brown	Y	50/5000
FCT512805	0.5ml	Self-standing	White	Y	50/5000
FCT312905	0.5ml	Self-standing	Black	Y	50/5000
FCT611005	0.5ml	Conical	Natural	N	50/5000
FCT611105	0.5ml	Conical	Red	N	50/5000
FCT611205	0.5ml	Conical	Orange	N	50/5000
FCT611305	0.5ml	Conical	Bule	N	50/5000
FCT611405	0.5ml	Conical	Yellow	N	50/5000
FCT611505	0.5ml	Conical	Green	N	50/5000
FCT611605	0.5ml	Conical	Pink	N	50/5000
FCT611705	0.5ml	Conical	Brown	N	50/5000
FCT611805	0.5ml	Conical	White	N	50/5000
FCT611905	0.5ml	Conical	Black	N	50/5000
FCT612005	0.5ml	Conical	Natural	Y	50/5000
FCT612105	0.5ml	Conical	Red	Y	50/5000
FCT612205	0.5ml	Conical	Orange	Y	50/5000
FCT612305	0.5ml	Conical	Bule	Y	50/5000
FCT612405	0.5ml	Conical	Yellow	Y	50/5000
FCT612505	0.5ml	Conical	Green	Y	50/5000
FCT612605	0.5ml	Conical	Pink	Y	50/5000
FCT612705	0.5ml	Conical	Brown	Y	50/5000
FCT612805	0.5ml	Conical	White	Y	50/5000
FCT612905	0.5ml	Conical	Black	Y	50/5000
FCT511015	1.5ml	Self-standing	Natural	N	50/5000
FCT511115	1.5ml	Self-standing	Red	N	50/5000
FCT511215	1.5ml	Self-standing	Orange	N	50/5000
FCT511315	1.5ml	Self-standing	Bule	N	50/5000
FCT511415	1.5ml	Self-standing	Yellow	N	50/5000
FCT511515	1.5ml	Self-standing	Green	N	50/5000
FCT511615	1.5ml	Self-standing	Pink	N	50/5000
FCT511715	1.5ml	Self-standing	Brown	N	50/5000
FCT511815	1.5ml	Self-standing	White	N	50/5000
FCT511915	1.5ml	Self-standing	Black	N	50/5000
FCT512015	1.5ml	Self-standing	Natural	Y	50/5000
FCT512115	1.5ml	Self-standing	Red	Y	50/5000
FCT512215	1.5ml	Self-standing	Orange	Y	50/5000
FCT512315	1.5ml	Self-standing	Bule	Y	50/5000
FCT512415	1.5ml	Self-standing	Yellow	Y	50/5000
FCT512515	1.5ml	Self-standing	Green	Y	50/5000
FCT512615	1.5ml	Self-standing	Pink	Y	50/5000
FCT512715	1.5ml	Self-standing	Brown	Y	50/5000
FCT512815	1.5ml	Self-standing	White	Y	50/5000
FCT512915	1.5ml	Self-standing	Black	Y	50/5000
FCT611015	1.5ml	Conical	Natural	N	50/5000
FCT611115	1.5ml	Conical	Red	N	50/5000
FCT611215	1.5ml	Conical	Orange	N	50/5000
FCT611315	1.5ml	Conical	Bule	N	50/5000



## Medium Bottles

- \* Bottle is used with PETG, free of heavy metal
- \* Screw cap is used with HDPE (High Density Polyethylene), free of heavy metal
- \* Bottle is embossed graduation two sided
- \* Shelf life is three year after month of production
- \* All used materials meet the legal requirements of FDA
- \* Temperature range from -60°C to 60°C
- \* Non-autoclavability
- \* Free of detectable DNase/RNase, human DNA and pyrogens

Cat.No	Volumes(ml)	Cap Color	Sterile	Per Case
SSB020500	500	white	Y	24/48
SSB000500	500	White	N	24/48
SSB021500	500	Light Green	Y	24/48
SSB001500	500	Light Green	N	24/48

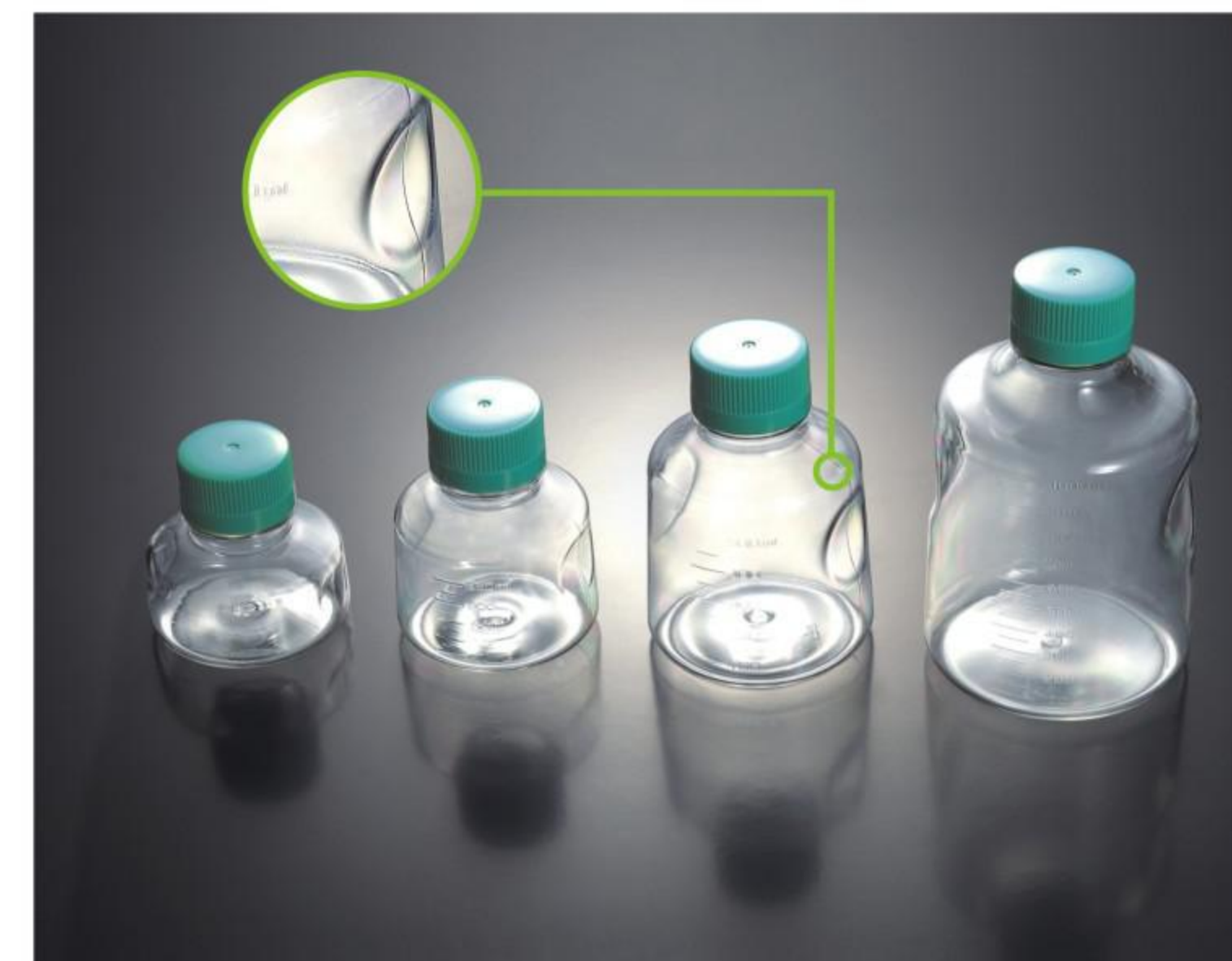

## Solution Bottles

**Solution Bottles are safe for solution storage. The material specialty ensures the bottles chemical-resistant.**

- \* Available with 5 different volumes of 150, 250, 500, 1000 and 2000ml
- \* Light weight
- \* Heavy wall construction and edge knurls on the cap for easy screw
- \* Designed wide and easy access mouth for efficiently and stably pour out
- \* Engraved or silk-printed graduation
- \* Special concave for easy handling
- \* Sterilized by gamma irradiation
- \* DNase/RNase-free & Non-pyrogenic

### Order Information

- \* Single package in easy-open packs to assure contamination-free
- \* Bottle cap is individually packed in package bag
- \* Every package bag is labeled with lot number for quality traceability

Cat.No	Volume(ml)	Sterile	Qty.per bag/case
CTF010150	150	Y	1/24
CTF010250	250	Y	1/24
CTF010500	500	Y	1/24
CTF010001	1000	Y	1/24
CTF010002	2000	Y	1/12

## Bio-Reaction Tubes

**Bio-Reaction tubes are manufactured from high quality polypropylene, offer a convenient and economical option for small scale, high density suspension cell culture. Bio-reaction tubes consist of centrifuge tubes with a 0.22µm hydrophobic membrane in the vent cap. These tubes are perfect for biological reaction experiments that require aseptic conditions with free gas exchange.**

- \* Available with 2 volumes of 15 and 50ml
- \* Conical bottom and self-standing bottom
- \* Caps have an ultrasonically welded 0.22µm hydrophobic membrane to allow gas exchange
- \* With a large unerasable frosting white printed writing area
- \* Save money with the ability to culture and centrifuge in one tube
- \* Maximum RCF is 12,000xg
- \* Engraved graduation at the conical bottom of each tube
- \* Leak proof
- \* Sterilized by gamma irradiation
- \* Non-pyrogenic

### Bio-Reaction Cap

Cat.No	Volume(ml)	Speciality	Sterile	Qty.per bag/case
BRC000050	50	Tube Cap	Y	25/1000

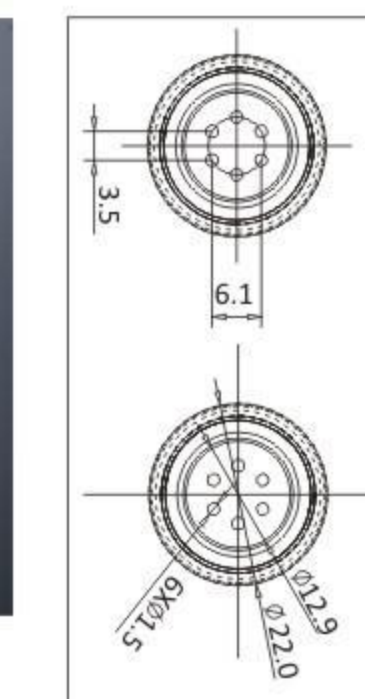

### Order Information

- \* Tubes are packaged in durable and resealable(zip closure) bags
- \* Every bag/case has printed lot No. for quality traceability

Cat.No	Volume(ml)	Bottom	max Rotate Speed(xg)	Sterile	Package	Qty.per bag/case
BRT000015	15	Conical	12,000	Y	Re-sealable bag	10/100
BRT010015	15	Conical	12,000	Y	Rack	50/300
BRT000050	50	Conical	12,000	Y	Re-sealable bag	10/100
BRT010050	50	Conical	12,000	Y	Rack	25/300
BRT011050	50	Self-standing	6,000	Y	Re-sealable bag	10/100

## Culture Tubes

**Culture tubes are mainly used for tissue culture, bacterial culture, storage of clinical samples, powder or liquid samples, as a variety of molecular biology test consumables, such as Elisa experiments, RIA analysis experiments and flow cytometry. The use of disposable plastic culture tubes is ideal for clinical sample storage, bacterial tissue culture, and molecular biology testing consumables.**

- \* Available with high-quality polypropylene or polystyrene
- \* Available with Plug Caps or Dual-Position Caps
- \* Colorless and transparent are perfect for biological reactor experiments

- \* Thicker walls will not crush
- \* Conical bottom and U bottom
- \* DNase/RNase-free and non-pyrogenic
- \* Sterilized by Gamma irradiation



Cat.No	Volume(ml)	Cap Styles	Material	Sterile	Qty.per bag/case
TUB000004	4	No Cap	PP	N	1000
TUB010004	4	No Cap	PS	N	1000
TUB020004	4	Dual Cap	PP	Y	25/500
TUB012004	4	Dual Cap	PS	Y	25/500
TUB000005	5	No Cap	PP	N	1000
TUB011005	5	No Cap	PS	N	1000
TUB022005	5	Dual Cap	PP	Y	25/500
TUB023005	5	Dual Cap	PS	Y	25/500

Cat.No	Volume(ml)	Cap Styles	Material	Sterile	Qty.per bag/case
TUB025005	5	Plug Cap	PP	Y	25/500
TUB028005	5	Plug Cap	PS	Y	25/500
TUB000008	8	No Cap	PP	N	1000
TUB010008	8	No Cap	PS	N	1000
TUB002008	8	No Cap	PP	Y	125/100
TUB013008	8	No Cap	PS	Y	125/1000
TUB002140	14	No Cap	PP	N	1000
TUB004140	14	No Cap	PS	N	1000



### Roller Bottles for Cell and Tissue Culture

**Roller Bottles are optimal applications for large yield of cell growth and multiplication, that can be used in both research and manufacturing, including the growing of mammalian cells for purposes of virus propagation and bio-product production.**

- \* Available with 3 bottle volumes of 1000ml, 2000ml, 5000ml
- \* Wide cell growth area of 490cm<sup>2</sup>, 850cm<sup>2</sup>, 1700cm<sup>2</sup>, 1900cm<sup>2</sup> for adhesions and huge growth volume for suspension
- \* Available surface-treated or non-treated
- \* Designed in large knurls on the cap for easy grip
- \* 2 different cap styles can be used in both open and closed systems
- \* Bottle surface is smooth and free from striation to maximize usable area for growth
- \* Every bottle has silk-printed graduation
- \* Suitable for all the common instruments and automation
- \* Sterilized by gamma irradiation
- \* Non-pyrogenic

#### Order Information

- \* Single package in peel to open plastic bags to assure contamination free
- \* Bottle cap is individually wrapped in package bag
- \* Every package case has labeled lot Number

Cat.No	Volume(ml)	Surface Type	Approx. Cell Growth Area(cm <sup>2</sup> )	Cap Style	Sterile	Qty. per bag/case
TCB001001	1000	General, Non-treated	490	Standard	Y	1/24
TCB002001	1000		Vent	Y	1/24	
TCB001002	2000		Standard	Y	1/12	
TCB002002	2000		Vent	Y	1/12	
TCB001005	5000		Standard	Y	1/12	
TCB002005	5000		Vent	Y	1/12	
TCB021005	5000		Standard	Y	1/12	
TCB022005	5000		Vent	Y	1/12	

Cat.No	Volume(ml)	Surface Type	Approx. Cell Growth Area(cm <sup>2</sup> )	Cap Style	Sterile	Qty. per bag/case
TCB011001	1000	Standard, Surface Treated	490	Standard	Y	1/24
TCB012001	1000		Vent	Y	1/24	
TCB011002	2000		Standard	Y	1/12	
TCB012002	2000		Vent	Y	1/12	
TCB031002	2000		Standard	Y	1/12	
TCB032002	2000		Vent	Y	1/12	
TCB011005	5000		Standard	Y	1/12	
TCB012005	5000		Vent	Y	1/12	
TCB031005	5000		Standard	Y	1/12	
TCB032005	5000		Vent	Y	1/12	

### Round-Bottom Tubes with Dual-position Cap

- \* Made with high-quality polypropylene
- \* Molded graduations stand out distinctly on these optically clear tubes
- \* Colorless and transparent are perfect for biological reaction experiments
- \* Thicker walls will not crush
- \* Available in sterilized or non-sterilized
- \* DNase/RNase-free and non-pyrogenic

Cat.No	Volume(ml)	Description	Sterile	Qty. per bag/case
TUB000140	14	Polypropylene, Clear, 17*100mm, Round Bottom Tube	N	50/500
TUB011140	14		Y	25/500
TUB100140	14	Polystyrene, Clear, 17*100mm, Round Bottom Tube	N	25/500
TUB111140	14		Y	25/500



### Single well plates

- \* Single well plates have increased in internal plating dimension, providing larger area for area cell growth
- \* Plates have standard external footprint, making them compatible with other instruments that accept SBS-standard plates
- \* For use in applications where cell attachment is not desired
- \* Temperature range:-20°C to 50°C
- \* Sterilized by gamma irradiation
- \* Non-pyrogenic & DNase/RNase-free

#### Plastic Blister Packaged

Cat.No	Well Qty.	Surface Type	Working Volume(cm <sup>2</sup> )	Lid	Sterile	Qty. per bag/case
TCP011001	1	Standard, surface treated	93.5-94	Y	Y	1/100
TCP001001	1	General, Non-treated	93.5-94	Y	Y	1/100

#### Tyvek Paper , Individually Packaged

Cat.No	Well Qty.	Surface Type	Working Volume(cm <sup>2</sup> )	Lid	Sterile	Qty. per bag/case
TCP010001	1	Standard, surface treated	93.5-94	Y	Y	1/200
TCP000001	1	General, Non-treated	93.5-94	Y	Y	1/200

### 96 Well Detachable Flat Plate

- \* Uniform well volume ensures equal growth surface area
- \* Flat well bottom with 96 well detachable frames
- \* Well surface is smooth and free from striation to maximize usable growth area
- \* Raised rims on wells with the uniform rings on the lid to reduce evaporation
- \* Single position lid reduces the risks of cross-contamination and the handling mistakes
- \* Wells are labeled with alphanumeric code for easy identification
- \* Suitable for all common instruments and automation
- \* 8 well strip is supplied in order to satisfy different sample quantity and economize coat
- \* Sterilized by gamma irradiation
- \* Non-pyrogenic

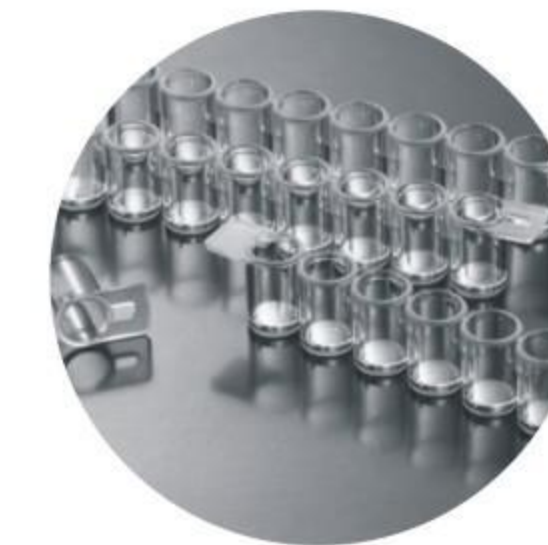

#### Order Information

- \* Individually packaged in peel-to-open paper/plastic blister pack
- \* Every case has printed with lot No. for quality traceability

Cat.No	Description	Qty. per bag/case
TCP011896	Frame for 8w x 12 strips, Standard, Surface treated, Sterile	1/100
TCP001896	Frame for 8w x 12 strips, General, Non-treated, Sterile	1/100

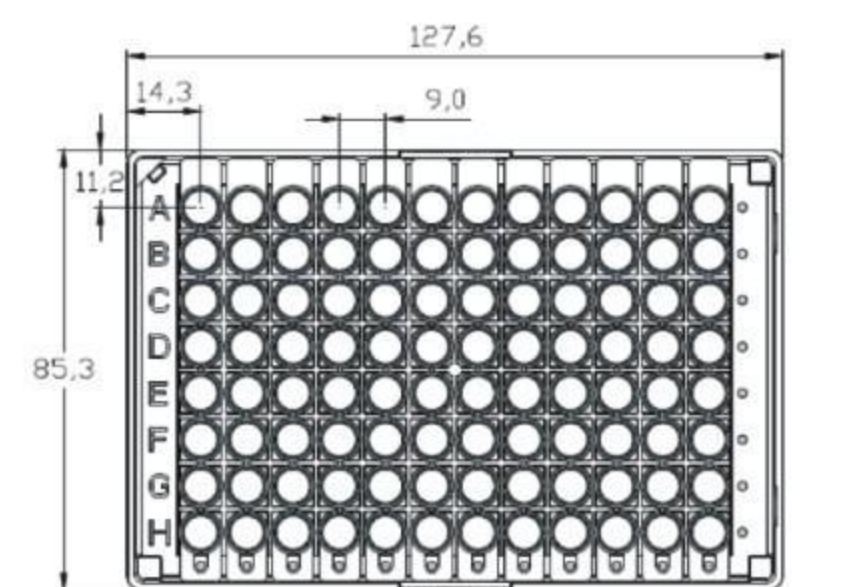
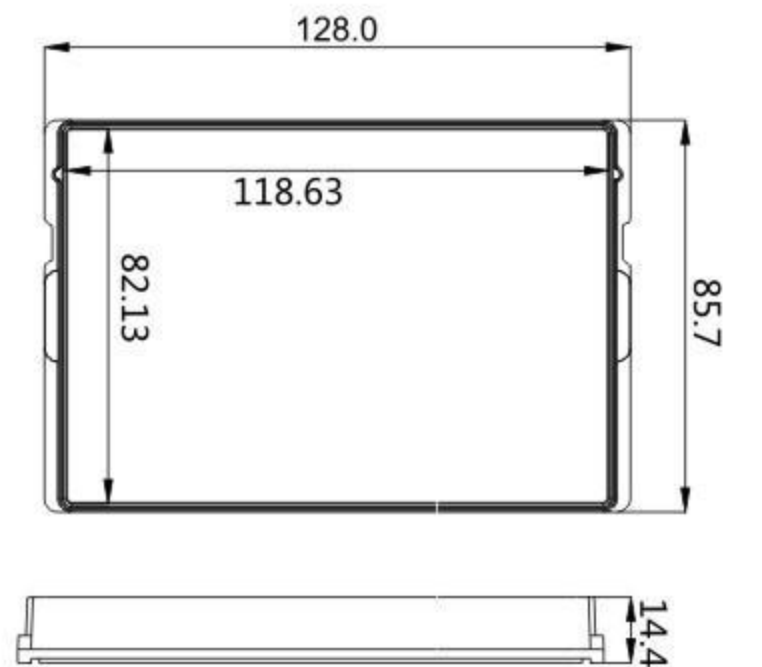

# PIPETTE PRODUCTS

Pipets Products series, including serological pipets, aspirating pipets, transfer pipettes and rechargeable pipet aid.

All the pipets are manufactured with exclusively high-grade polystyrene(PS) or Polyethylene(PE) which are excellent for clear observation and reducing liquid attachment on the pipet surface to assure accurate delivery. The manufacturing environment is mastered by both ISO9001, ISO13485 quality management and 100.000 grade clean-room cleanness system.

Furthermore, the universal design makes the pipets suitable for most brands of pipet-aid. Additionally, gamma irradiation sterilized or non-sterilized products are available in order to meet the different research needs and enhance the practicability. All the features guarantee them can be safely used in cell and tissue culture, bacteriological and clinical research.

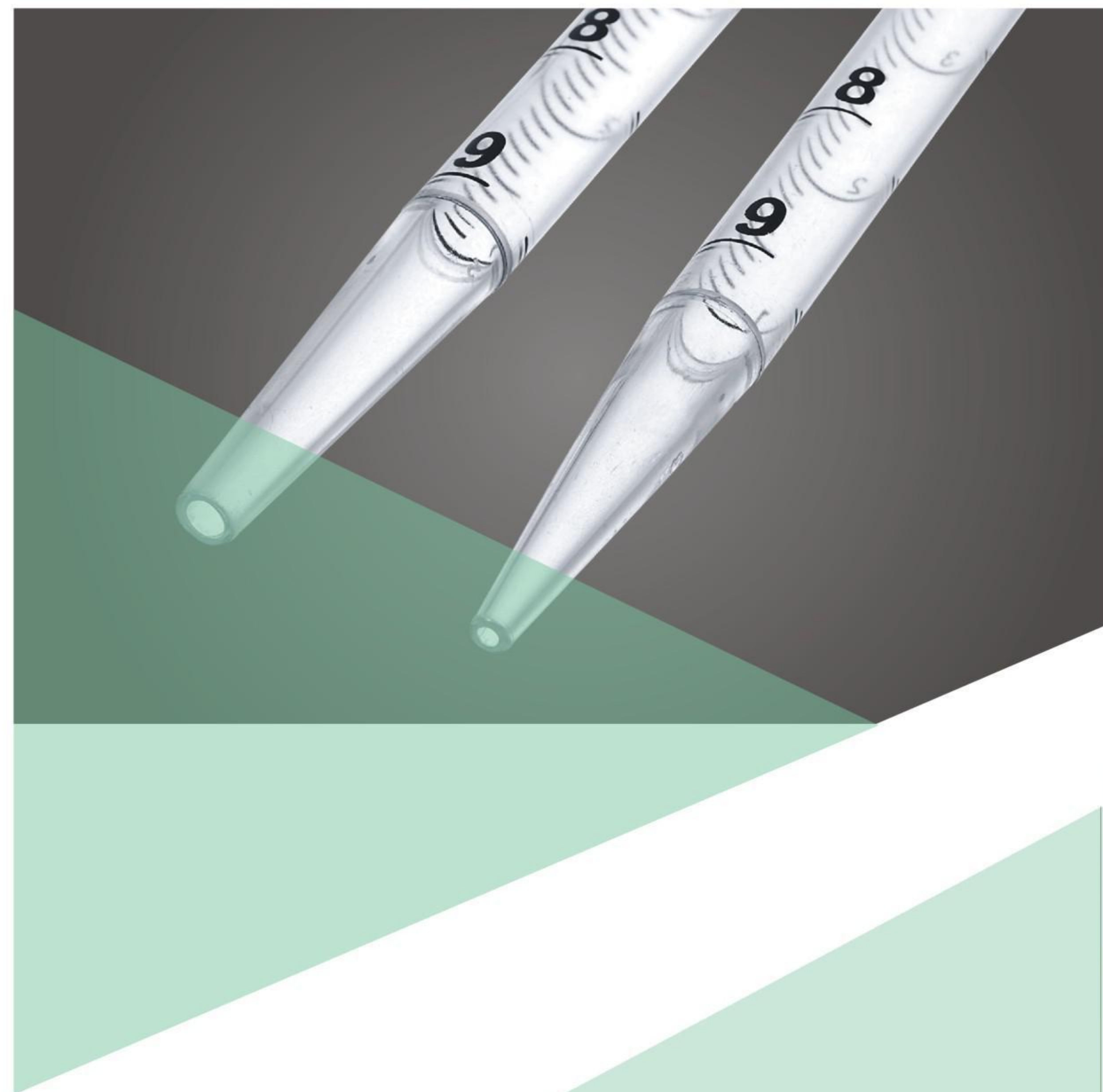

## Serological Pipets

- \* Available with 7 capacities of 1.0, 2.0, 5.0, 10.0, 25.0, 50.0ml and 100.0ml
- \* 1.0, 2.0, 5.0ml are stretched, while 25.0, 50.0ml and 100.0ml are ultrasonically welded at tip and mouth piece
- \* Both stretched mouth and ultrasonically welded mouth are available for 10ml pipet
- \* Graduations are calibrated for accurate dispensing to within  $\pm 1\%$
- \* Different color rings are for easy identification
- \* Bidirectional graduations on the pipets provide added applicability
- \* Negative graduation allows additional working volume
- \* All pipets are supplied with a filter plug
- \* Strict consistency tested
- \* Non-pyrogenic

## Ordering Information

- \* Individually packed in peel-to-open wrap with lot. No. for quality traceability
- \* Carton has been specially designed for efficient bench top dispensing with a removable perforated front panel
- \* Also available with bulk package in easy-to-open bag
- \* Available with gamma irradiation sterilized or non-sterilized



## Serological Pipets Individually Package (paper/plastic)

Cat.No	Volume(ml)	Length(mm)	Graduation(ml)	Color Code	Sterile	Package	Qty. Per bag/case
GSP010001	1	268.5 $\pm$ 2.0	1/100	Yellow	Y	Paper/Plastic	500
GSP010002	2	272.0 $\pm$ 2.0	1/50	Green	Y	Paper/Plastic	500
GSP010102	2	272.0 $\pm$ 2.0	1/100	Green	Y	Paper/Plastic	500
GSP010005	5	341.0 $\pm$ 2.0	1/10	Blue	Y	Paper/Plastic	200
GSP010010	10	346.3 $\pm$ 2.0	1/10	Orange	Y	Paper/Plastic	200
GSP010110	10, Wide Mouth	346.3 $\pm$ 2.0	1/10	Orange	Y	Paper/Plastic	200
GSP211010	10, Stretched Mouth	346.3 $\pm$ 2.0	1/10	Orange	Y	Paper/Plastic	200
GSP010025	25	308.5 $\pm$ 2.0	2/10	Red	Y	Paper/Plastic	150
GSP010125	25, Long	338.9 $\pm$ 2.0	2/10	Red	Y	Paper/Plastic	150
GSP010050	50	346.2 $\pm$ 2.0	5/10	Purple	Y	Paper/Plastic	100
GSP010100	100	346.8 $\pm$ 2.0	1	Pink	Y	Paper/Plastic	50



**Serological Pipets Individually Vacuum Package in bag (paper/plastic)**

Cat.No	Volume(ml)	Length(mm)	Graduation(ml)	Color Code	Sterile	Package	Qty. Per bag/case
GSP110001	1	268.5±2.0	1/100	Yellow	Y	Paper/Plastic	100/600
GSP110002	2	272.0±2.0	1/50	Green	Y	Paper/Plastic	100/500
GSP110102	2	272.0±2.0	1/100	Green	Y	Paper/Plastic	100/500
GSP110005	5	341.0±2.0	1/10	Blue	Y	Paper/Plastic	100/200
GSP110010	10	346.3±2.0	1/10	Orange	Y	Paper/Plastic	50/200
GSP110110	10, Wide Mouth	346.3±2.0	1/10	Orange	Y	Paper/Plastic	50/200
GSP210010	10, Stretched Mouth	346.3±2.0	1/10	Orange	Y	Paper/Plastic	25/400
GSP110025	25	308.5±2.0	2/10	Red	Y	Paper/Plastic	50/150
GSP110125	25, Long	338.9±2.0	2/10	Red	Y	Paper/Plastic	50/150
GSP110050	50	346.2±2.0	5/10	Purple	Y	Paper/Plastic	30/90
GSP110100	100	346.8±2.0	1	Pink	Y	Paper/Plastic	10/50

**Serological Pipets Bulk Vacuum Package**

Cat.No	Volume(ml)	Length(mm)	Graduation(ml)	Color Code	Sterile	Qty. Per bag/case
GSP012001	1	268.5±2.0	1/100	Yellow	Y	25/1000
GSP012002	2	272.0±2.0	1/50	Green	Y	25/1000
GSP012102	2	272.0±2.0	1/100	Green	Y	25/1000
GSP012005	5	341.0±2.0	1/10	Blue	Y	25/500
GSP012010	10	346.3±2.0	1/10	Orange	Y	25/400
GSP012110	10, Wide Mouth	346.3±2.0	1/10	Orange	Y	25/400
GSP112010	10, Stretched Mouth	346.3±2.0	1/10	Orange	Y	25/400
GSP012025	25	308.5±2.0	2/10	Red	Y	10/150
GSP012125	25, Long	338.9±2.0	2/10	Red	Y	10/150
GSP012050	50	346.2±2.0	5/10	Purple	Y	10/100
GSP012100	100	346.8±2.0	1	Pink	Y	10/60
GSP011001	1	268.5±2.0	1/100	Yellow	N	25/1000
GSP011002	2	272.2±2.0	1/50	Green	N	25/1000
GSP011102	2	272.0±2.0	1/100	Green	N	25/1000
GSP011005	5	341.0±2.0	1/10	Blue	N	25/500
GSP011010	10	346.3±2.0	1/10	Orange	N	25/400
GSP011110	10, Wide Mouth	346.3±2.0	1/10	Orange	N	25/400
GSP111010	10, Stretched Mouth	346.3±2.0	1/10	Orange	N	25/400
GSP011025	25	308.5±2.0	2/10	Red	N	10/150
GSP011125	25, Long	338.9±2.0	2/10	Red	N	10/150
GSP011050	50	346.2±2.0	5/10	Purple	N	10/100
GSP011100	100	346.8±2.0	1	Pink	N	10/60

**Serological Pipets Individually Package (plastic/plastic)**

Cat.No	Volume(ml)	Length(mm)	Graduation(ml)	Color Code	Sterile	Package	Qty. Per case
GSP020001	1	268.5±2.0	1/100	Yellow	Y	Plastic Bag	500
GSP020002	2	272.0±2.0	1/50	Green	Y	Plastic Bag	500
GSP020102	2	272.0±2.0	1/100	Green	Y	Plastic Bag	500
GSP020005	5	341.0±2.0	1/10	Blue	Y	Plastic Bag	200
GSP020010	10	346.3±2.0	1/10	Orange	Y	Plastic Bag	200
GSP020110	10, Wide Mouth	346.3±2.0	1/10	Orange	Y	Plastic Bag	200
GSP021010	10, Stretched Mouth	346.3±2.0	1/10	Orange	Y	Plastic Bag	200
GSP020025	25	308.5±2.0	2/10	Red	Y	Plastic Bag	150
GSP020125	25, Long	338.9±2.0	2/10	Red	Y	Plastic Bag	150
GSP020050	50	346.2±2.0	5/10	Purple	Y	Plastic Bag	100
GSP020100	100	346.8±2.0	1	Pink	Y	Plastic Bag	50

**Serological Pipets Individually Vacuum Package in bag (plastic/plastic)**

Cat.No	Volume(ml)	Length(mm)	Graduation(ml)	Color Code	Sterile	Package	Qty. Per bag/case
GSP120001	1	268.5±2.0	1/100	Yellow	Y	Plastic Bag	100/600
GSP120002	2	272.0±2.0	1/50	Green	Y	Plastic Bag	100/500
GSP120102	2	272.0±2.0	1/100	Green	Y	Plastic Bag	100/500
GSP120005	5	341.0±2.0	1/10	Blue	Y	Plastic Bag	100/200
GSP120010	10	346.3±2.0	1/10	Orange	Y	Plastic Bag	50/200
GSP120110	10, Wide Mouth	346.3±2.0	1/10	Orange	Y	Plastic Bag	50/200
GSP121010	10, Stretched Mouth	346.3±2.0	1/10	Orange	Y	Plastic Bag	50/200
GSP120025	25	308.5±2.0	2/10	Red	Y	Plastic Bag	50/150
GSP120125	25, Long	338.9±2.0	2/10	Red	Y	Plastic Bag	50/150
GSP120050	50	346.2±2.0	5/10	Purple	Y	Plastic Bag	30/90
GSP120100	100	346.8±2.0	1	Pink	Y	Plastic Bag	10/50

**Mini™ Serological Pipets**

Mini pipets are specially designed for liquid handling operation in limited working space. These special designed pipets are significantly shorter than the normal pipet, only 9.25 inches. They come in three different volumes: 5.0ml, 10.0ml and 25.0ml.

**Ordering Information**

- \* Available individually wrapped in an easy opening paper/plastic wrapped with lot number traceability
- \* Inner boxes have been specially designed for efficient bench top dispensing with a removable perforated front panel
- \* Also available with bulk package in easy to open bag

Cat.No	Volume(ml)	Graduation	Color Ring	Material	Sterile	Package	Qty. per bag/case
GSP010205	5.0	1/10	Blue	PS	Y	Paper/Plastic	1/200
GSP010210	10.0	2/10	Orange	PS	Y	Paper/Plastic	1/150
GSP010225	25.0	5/10	Red	PS	Y	Paper/Plastic	1/100

**Aspirating Pipets**

Aspirating pipets are ideal for liquid transfer of mix

Cat.No	Capacity(ml)	Length(mm)	Material	Sterile	Package	Qty. per bag/case
GSP000001	1.0	268.5±2.0	PS	Y	Plastic Bag	25/1000
GSP000002	2.0	272.0±2.0	PS	Y	Plastic Bag	25/1000
GSP000005	5.0	341.0±2.0	PS	Y	Plastic Bag	25/400
GSP000010	10.0	346.3±2.0	PS	Y	Plastic Bag	25/500
GSP000025	25.0	308.5±2.0	PS	Y	Plastic Bag	10/150
GSP000125	25.0, Long	338.9±2.0	PS	Y	Plastic Bag	10/150
GSP000050	50.0	346.2±2.0	PS	Y	Plastic Bag	10/100
GSP000100	100	346.8±2.0	PS	Y	Plastic Bag	10/60
GSP001001	1.0	268.5±2.0	PS	N	Plastic Bag	25/1000
GSP001002	2.0	272.0±2.0	PS	N	Plastic Bag	25/1000
GSP001005	5.0	341.0±2.0	PS	N	Plastic Bag	25/500
GSP001010	10.0	346.3±2.0	PS	N	Plastic Bag	25/400
GSP001025	25.0	308.5±2.0	PS	N	Plastic Bag	10/150
GSP001125	25.0, Long	338.9±2.0	PS	N	Plastic Bag	10/150
GSP001050	50.0	346.2±2.0	PS	N	Plastic Bag	1/200
GSP001100	100	346.8±2.0	PS	N	Plastic Bag	1/200

**10ml Aspirating pipets (stretched)**

Cat.No	Capacity(ml)	Length(mm)	Material	Sterile	Package	Qty. per bag/case
GSP002010	10.0	346.3±2.0	PS	Y	Plastic	25/400
GSP003010	10.0	346.3±2.0	PS	N	Plastic	25/400
GSP101010	10.0	346.3±2.0	PS	Y	Paper/Plastic	50/200
GSP201010	10.0	346.3±2.0	PS	Y	Paper/Plastic	50/200

- \* Available with 7 capacities of 1.0, 2.0, 5.0, 10.0, 25.0, 50.0 and 100.0ml
- \* 1.0, 2.0, 5.0, 10.0ml are stretched, while 10.0, 25.0, 50.0 and 100.0ml are ultrasonically welded at tip and mouthpiece
- \* Colorless and transparent
- \* Strict consistency tested
- \* Non-pyrogenic

**Ordering Information**

- \* Available with bulk package in easy to open plastic bags
- \* Every case has printed lot No. for quality traceability
- \* Available in sterilized or non-sterilized





## Transfer Pipets

Disposable transfer pipets are perfect products for quick, safe transfer of fluid.

- \* Available with 3 different capacities of 0.2, 1.0 and 3.0ml
- \* Long flexible stem can be bent to draw liquid from narrow or small volume tubes into the bulb
- \* Can be used in liquid nitrogen
- \* Uniform drop size

### Ordering Information

- \* Individually package in peel-to-open paper/plastic bag is available
- \* Also available with bulk package in easy to open plastic bag
- \* Every case has printed lot No. for quality traceability
- \* Available in gamma irradiation sterilized or non-sterilized

### Individually package

Cat.No	Capacity(ml)	Length(mm)	Sterile	Qty. Per bag/case
PP101002	0.2	68	Y	1/5000
PP101010	1.0	150	Y	1/4000
PP101030	3.0	155	Y	1/4000
PP102030	3.0	180	Y	1/4000
PP103030	3.0	180	Y	1/4000

### Bulk package

Cat.No	Capacity(ml)	Length(mm)	Sterile	Qty. Per bag/case
PP000002	0.2	68	N	100/10000
PP000010	1.0	150	N	100/5000
PP003030	3.0	180	N	100/5000
PP001002	0.2	68	Y	100/10000
PP001010	1.0	150	Y	100/5000
PP101030	3.0	155	Y	100/5000
PP002030	3.0	180	Y	100/5000

### Individually wrapped in box

Cat.No	Volume(ml)	Length(mm)	Sterile	Qty.Per. Bag	Qty.Per. Case
PP201010	1.0	150	Y	1	2000
PP205010	1.0	150	Y	1	2000
PP201030	3.0	155	Y	1	2000
PP205030	3.0	180	Y	1	2000
PP202030	3.0	155	N	200	2000
PP203030	3.0	180	N	200	2000
PP200010	1.0	150	N	200	2000
PP200030	3.0	155	N	200	2000
PP303030	3.0	180	N	200	2000

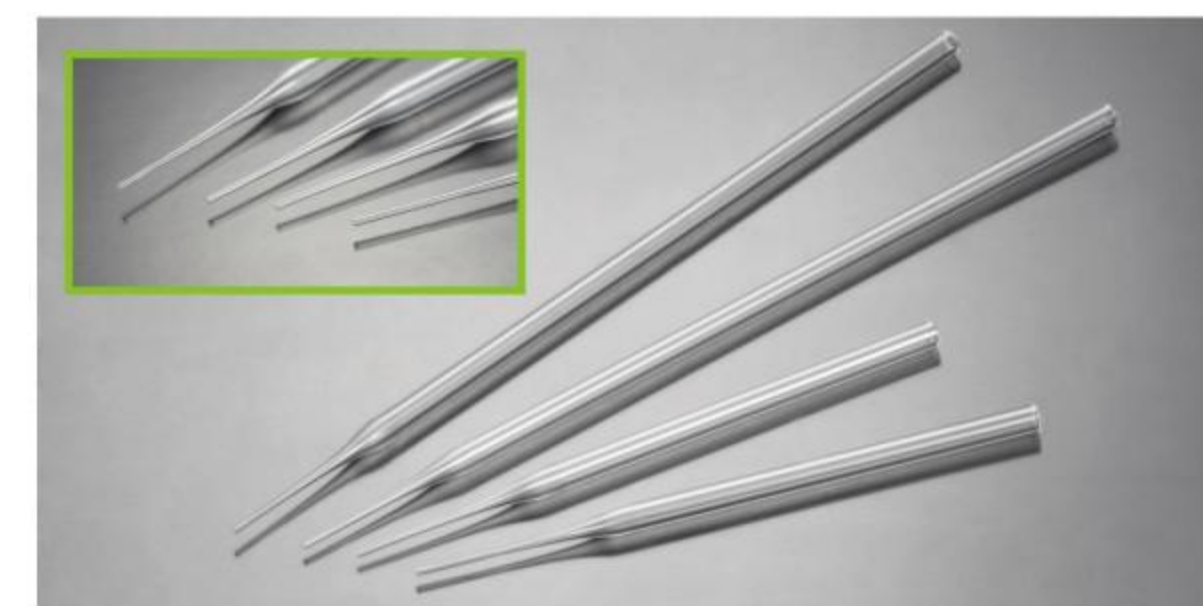

### Ordering Information

- \* Available with bulk package or individually wrapped in easy-to-open bag
- \* Every case has printed lot No. for quality traceability



## Plastic Pasteur Pipets

- \* Long flexible stem can be bent to draw liquid from narrow or small volume tubes into the bulb
- \* Offer the aspirating precision of a glass pipet and the safety benefits of plastic
- \* Available in two sizes: 145 mm and 230 mm for easier handling and longer reach for working with larger vessels
- \* Sterilized by gamma irradiation
- \* Strict consistency tested

Cat.No	Length(mm)	Material	Sterile	Package	Qty.per bag/case
PP000145	145	PS	Y	Individually	50/200
PP010145	145	PS	Y	Bulk	25/200
PP000230	230	PS	Y	Individually	50/200
PP010230	230	PS	Y	Bulk	25/200

## Pipette controller

Pipette controller is high technical and exact assistant device for 1 to 100 ml plastic or glass pipets.

- \* Light weight and cordless for convenient use. If handled correctly, the device itself won't get in touch with any liquid
- \* The aspirating or dispensing speed of the pump can be controlled by the pump speed switch
- \* Constructed with recyclable materials
- \* Long life and environment-friendly with up to 8 hours rechargeable continuous electric power
- \* The filter with hydrophobic membrane assembled in aid can provide contamination free liquid handling

### Ordering Information

- \* Standard package includes 1 pipette controller, 1 charger, 1 desktop stand, manual, 1 wall mount bracket, two spare membrane filters: 0.2µm and 0.45µm, 1 instruction manual, 1 warranty card
- \* Changeable filter and charger are available
- \* EPE is padded in the case for extra protection

### Pipette controller

Cat.No	Voltage	Charger Type	Qty. per box
SPA001220	Universal	1.0~100ml	1
SPA003220		1.0~100ml	1
SPA004220		1.0~100ml	1

### Fittings

Cat.No	Name	Charger Type	Qty. per box
SPA010020	Filter(0.20um hydrophobic membrane)	--	5
SPA010045	Filter(0.45um hydrophobic membrane)	--	5
SPA020220	Charger	USA	1
SPA030220	Charger	UK	1
SPA040220	Charger	EU	1



### Micro Volume Pipettors

- \* Suitable for left and right handed user with a relaxed grip and a good balance
- \* Fully autoclavable
- \* UV resistant
- \* Resistance free click stop counter
- \* Larger digits
- \* Ergonomic design ensuring light weight & soft plunger movement
- \* Easily accessible recalibration mechanism to avoid accidental change in calibration
- \* Calibration conforms to DIN 12650 & EN-ISO 8655 standards ensuring high accuracy & precision

Cat.No	Name	Range(µl)	Increment(µl)	Accuracy(%)	Precision(%)	Package
SPA200125	Variable Volume Pipette	0.1-2.5	0.01	12/3.0/2.5	6.0/3.0/1.6	1
SPA200510		0.5-10	0.1	2.5/2.0/1.0	1.5/1.0/0.8	1
SPA200550		5-50	1.0	2.0/0.8/0.6	2.0/0.4/0.3	1
SPA210100		10-100	0.5	3.0/1.0/0.8	1.5/0.5/0.15	1
SPA200220		2-20	0.1	3.0/1.5/0.9	2.0/1.0/0.4	1
SPA220200		20-200	1.0	2.0/0.7/0.6	0.8/0.3/0.15	1
SPA211000		100-1000	5.0	2.0/1.0/0.6	0.7/0.4/0.2	1

Cat.No	Name	Range(µl)	Accuracy(%)	Precision(%)	Package
SPA100005	Fix Volume Pipette	5	1.3	1.2	1
SPA100010		10	0.8	0.8	1
SPA100050		50	0.5	0.3	1
SPA100100		100	0.5	0.3	1
SPA100500		500	0.3	0.2	1
SPA101000		1000	0.3	0.15	1

### Multichannel Micro Pipettors

- \* Soft smart finger-grip of TPE
- \* Easily removable & fully autoclavable manifold
- \* Manifold can rotate 360° for easy right or left hand operation
- \* One had tip ejection
- \* Consistent sample loading
- \* Soft force tip loading and ejection
- \* Leak free sealing of tip
- \* Attractive color coding
- \* Compatible with most types of tips
- \* Calibration report enclosed with every pipette



Cat.No	Qty.Channel	Range(µl)	Package
SPA008010	8	0.5-10	1
SPA008050	8	5-50	1
SPA008100	8	10-100	1
SPA008200	8	20-200	1
SPA008300	8	30-300	1

Cat.No	Qty.Channel	Range(µl)	Package
SPA012010	12	0.5-10	1
SPA012050	12	5-50	1
SPA012100	12	10-100	1
SPA012200	12	20-200	1
SPA012300	12	30-300	1

### JET Dispenser

Introducing a perfect partner for your high volume liquid dispensing. Equipped with modern and easy to use features.



#### Re-circulation Valve

Eliminates sample loss For rapid priming



#### Spring-less Valve

A highly chemical resistant and smooth functioning springless valve



#### Unique Piston Mechanism

Convenient cleaning of piston without disturbing the calibration



#### Easy Re-calibration

A single tool re-calibration mechanism which comply with ISO 8655 standards

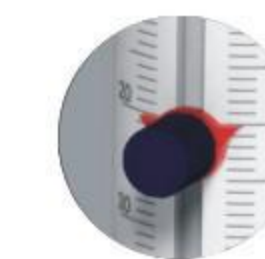

#### Dual Graduations

Precise volume setting Dual volume marking assures clear visibility



#### Fully Autoclavable



#### 360° Dispensing

Rotating discharge tube enables bottle visibility Convenient dispensing without moving the dispenser



#### Universal Bottle Adapter

Comes with 4 additional adapters for most common bottle sizes



#### Conductive Handling

Ergonomic design for convenient sampling Low pressure dispensing even for larger volumes



#### Telescopic Filling Tube

Compatible with different sizes of reagent bottles ranging from 170mm to 300mm



#### Uncomplicated Mounting

Snap-fit mounting of discharge tube for chemical based applications



Cat.No With Re-Circulation Mode	Cat.No Without Re-Circulation Mode	Volume Range (ml)	Volume Range (ml)
ADR025025	ADN025025	0.25 to 2.5	0.05
ADR050050	ADN050050	0.5 to 5	0.1
ADR100100	ADN100100	1 to 10	0.2
ADR250250	ADN250250	2.5 to 25	0.5
ADR250300	ADN250300	2.5 to 30	0.5
ADR500500	ADN500500	5 to 50	1.0
ADR500600	ADN500600	5 to 60	1.0



# Centrifuge Tubes Products

Centrifuge Tubes Products series, includes centrifuge tubes and micro centrifuge tubes. Special selected high clarity polypropylene assures the good transparency, chemical resistibility and obdurability. And the dual quality security system of ISO9001, ISO13485 quality management and 100,000 grade clean-room, control system insure the good quality. Furthermore, the universal design makes the tubes suitable for most brands of centrifuge. Additionally, either gamma irradiation sterilized or non-sterilized products are available in order to satisfy the different research requirements and enhance the practicability. All the features allow them to be widely used in chemical and life science research.

## Centrifuge Tubes

Centrifuge tubes are popular in samples centrifuging or storage in many research areas.

- \* Centrifuge tubes are popular in samples centrifuging or storage in many research areas
- \* Available with 2 volumes of 15 and 50ml
- \* 2 different cap styles: flat cap and plug seal cap
- \* Conical bottom, self-standing bottom and u bottom
- \* Longer length screw caps with sealing ring prevent any leakage
- \* Easy to read black graduations are accurate to ±2%, 1ml increments (15ml) or 2.5ml increments (50ml)
- \* With a large unerasable frosting white printed writing area
- \* Both the graduations and writing areas are chloroform-resistant
- \* Engraved graduation at the conical bottom of each tube
- \* Max rotate speed up to 12,000xg for conical bottom tubes and u bottom tubes, while 6,000xg for self-standing tubes
- \* Autoclavable at 121°C and freezable to -80°C

### Ordering Information

- \* Racked tubes are packaged in environmentally responsible (fully recyclable) chipboard racks
- \* Bagged tubes are packaged in durable and re-sealed (zip closure) bags
- \* Inner packaging is individually labelled for lot-to-lot traceability
- \* All tubes are packaged with caps attached and are available in sterilized with gamma irradiation, RNase-free, DNase-free and Non-pyrogenic

### High RCF Speciality Max Rotate Speed(xg)21,000

Cat.No	Capacity(ml)	Bottom	Max Rotate Speed(xg)	Sterile	Package	Qty. per bag/case
CFT312150	15	conical	21,000	Y	Re-sealable bag	25/500
CFT322150	15	conical	21,000	Y	Paper rack	25/500
CFT312500	50	conical	21,000	Y	Re-sealable bag	25/500
CFT322500	50	conical	21,000	Y	Paper rack	25/500

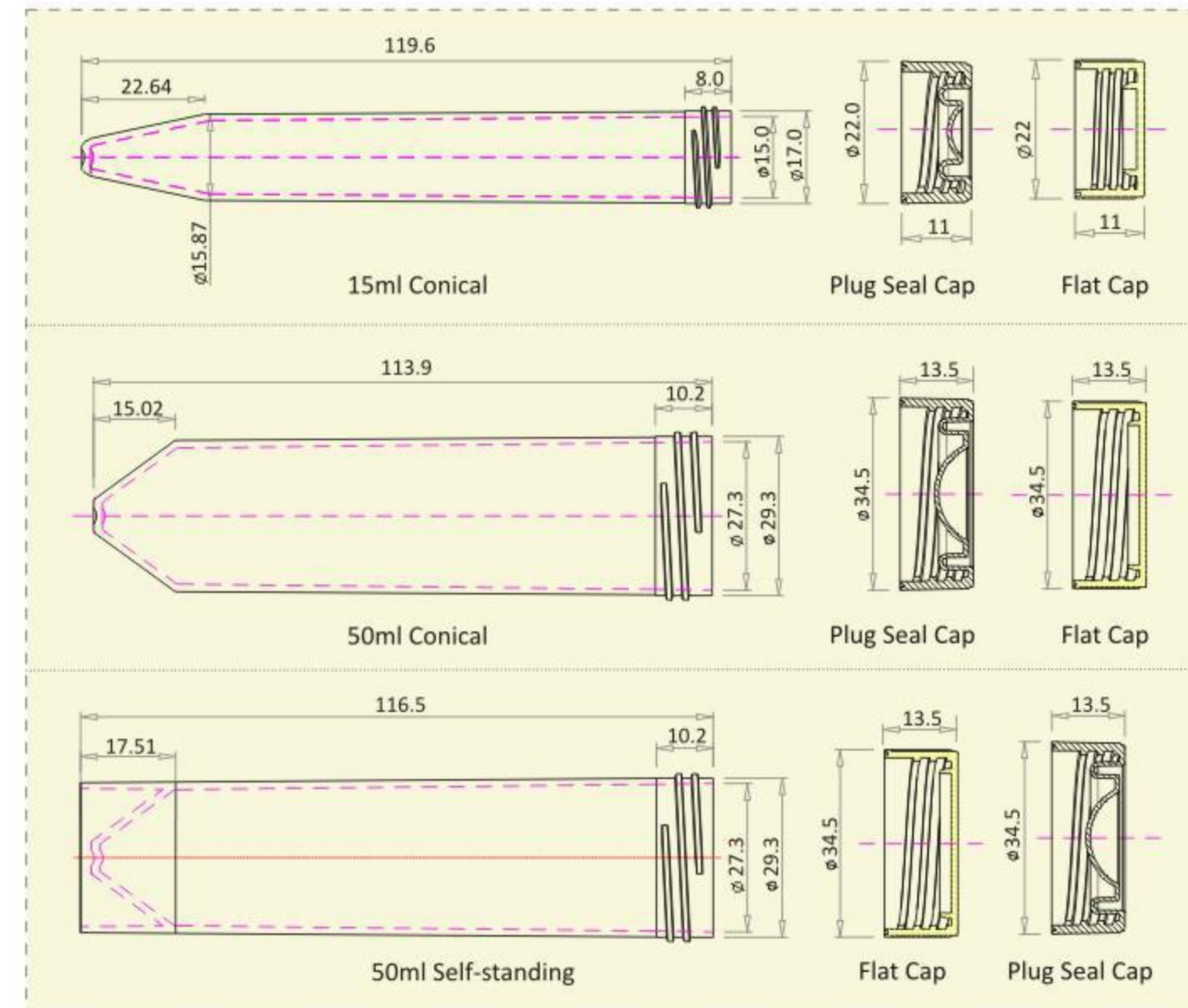

## Centrifuge Tubes with Flat Cap

Cat.No	Capacity(ml)	Bottom	Sterile	Max Rotate Speed(xg)	Package	Qty. per bag/case
CFT000150	15	Conical	N	12,000	Bulk	500
CFT010150	15	Conical	N	12,000	Re-sealable bag	50/500
CFT011150	15	Conical	Y	12,000	Re-sealable bag	25/500
CFT021150	15	Conical	Y	12,000	Paper rack	25/500
CFT000500	50	Conical	N	12,000	Bulk	500
CFT010500	50	Conical	N	12,000	Re-sealable bag	50/500
CFT011500	50	Conical	Y	12,000	Re-sealable bag	25/300
CFT021500	50	Conical	Y	12,000	Paper rack	25/300
CFT100500	50	Self-standing	N	6,000	Bulk	500
CFT111500	50	Self-standing	Y	6,000	Re-sealable bag	25/500
CFT110500	50	Self-standing	N	6,000	Re-sealable bag	25/500
CFT031500	50	Conical	Y	12,000	Plastic rack	25/300

## Centrifuge Tubes with Plug Seal Cap

Cat.No	Capacity(ml)	Bottom	Sterile	Max Rotate Speed(xg)	Package	Max Rotate Speed(xg) Package
CFT500150	15	Conical	N	12,000	Bulk	500
CFT510150	15	Conical	N	12,000	Re-sealable bag	50/500
CFT511150	15	Conical	Y	12,000	Re-sealable bag	25/500
CFT521150	15	Conical	Y	12,000	Paper rack	25/500
CFT621150	15	Conical	Y	12,000	Plastic rack	25/300
CFT500500	50	Conical	N	12,000	Bulk	500
CFT510500	50	Conical	N	12,000	Re-sealable bag	50/500
CFT511500	50	Conical	Y	12,000	Re-sealable bag	25/500
CFT521500	50	Conical	Y	12,000	Paper rack	25/500
CFT621500	50	Conical	Y	12,000	Plastic rack	25/300
CFT660500	50	Self-standing	N	6,000	Bulk	500
CFT610500	50	Self-standing	N	6,000	Re-sealable bag	25/500
CFT611500	50	Self-standing	Y	6,000	Paper rack	25/500

## High performance centrifugal tube

New Listing

Centrifuge tubes are popular in samples centrifuging or storage in many research area.

### Fluorescent green cap with sealing ring

- \* 2 different cap styles: flat cap and plug seal cap
- \* Longer length screw caps with sealing ring prevent any leakage
- \* With a large unerasable frosting white printed writing area
- \* Both the graduations and writing areas are chloroform-resistant
- \* Engraved graduation at the conical bottom of each tube
- \* Max rotate speed up to 21,000xg
- \* Autoclavable at 121°C and freezable to -80°C
- \* Leak-proof



## Amber Centrifuge Tubes

Cat.No	Capacity(ml)	Bottom	Sterile	Speciality	Max Rotate Speed(xg)	Package	Qty. per bag/case
CFT710150	15	Conical	N	White Plug Seal Cap; DNase/RNase-free	12,500	Re-sealable bag	50/500
CFT711150	15	Conical	Y	White Plug Seal Cap; DNase/RNase-free	12,500	Re-sealable bag	25/500
CFT712150	15	Conical	Y	White Plug Seal Cap; DNase/RNase-free	12,500	Plastic rack	25/500
CFT710500	50	Conical	N	White Plug Seal Cap; DNase/RNase-free	12,500	Re-sealable bag	50/500
CFT711500	50	Conical	Y	White Plug Seal Cap; DNase/RNase-free	12,500	Re-sealable bag	25/500
CFT712500	50	Conical	Y	White Plug Seal Cap; DNase/RNase-free	12,500	Paper rack	50/500



## SureSeal 50ml Centrifuge Tubes

Longer length screw caps with sealing ring prevent any leakage

- \* Conical bottom and self-standing bottom
- \* Easy-to-read black graduations are accurate to 2%, 2.5ml increments (50ml)
- \* With a large unerasable frosting white printed writing area
- \* Both the graduations and writing areas are chloroform-resistant
- \* Engraved graduation at the conical bottom of each tube
- \* Max rotate speed up to 12,000xg for conical bottom tubes, while 6,000xg for self-standing tubes
- \* Autoclavable at 121°C and freezable to -80°C
- \* Leak-proof

Cat.No	Capacity(ml)	Bottom	Speciality	Sterile	Max. Rotate Speed(xg)	Package	Qty. per bag/case
CFT656500	50	Conical	–	N	12,000	Bulk	500
CFT615500	50	Conical	DNase/RNase-free	Y	12,000	Re-sealable bag	25/500
CFT617500	50	Conical	DNase/RNase-free	Y	12,000	Paper rack	25/500
CFT614500	50	Self-standing	–	N	6,000	Bulk	500
CFT613500	50	Self-standing	DNase/RNase-free	Y	6,000	Re-sealable bag	25/500



## Metal-Free Centrifuge Tubes

- \* Meet the requirements of BSE/TSE
- \* Latex Statement: This product is latex free
- \* Non-pyrogenic: The acceptance level for product is 0.05 EU/ml. (Tachypleus Amebocyte Lysate [TAL] Clot-gel test)
- \* Centrifuge Tubes are certified to meet ROHS requirement

Cat.No	Capacity(ml)	Bottom	Sterile	Max Rotate Speed(xg)	Package	Qty. per bag/case
CFT450150	15	Conical	Y	12,500	Re-sealable bag	25/500
CFT451150	15	Conical	Y	12,500	Paper Rack	50/500
CFT450500	50	Conical	Y	12,500	Re-sealable bag	25/500
CFT451500	50	Conical	Y	12,500	Paper Rack	25/500

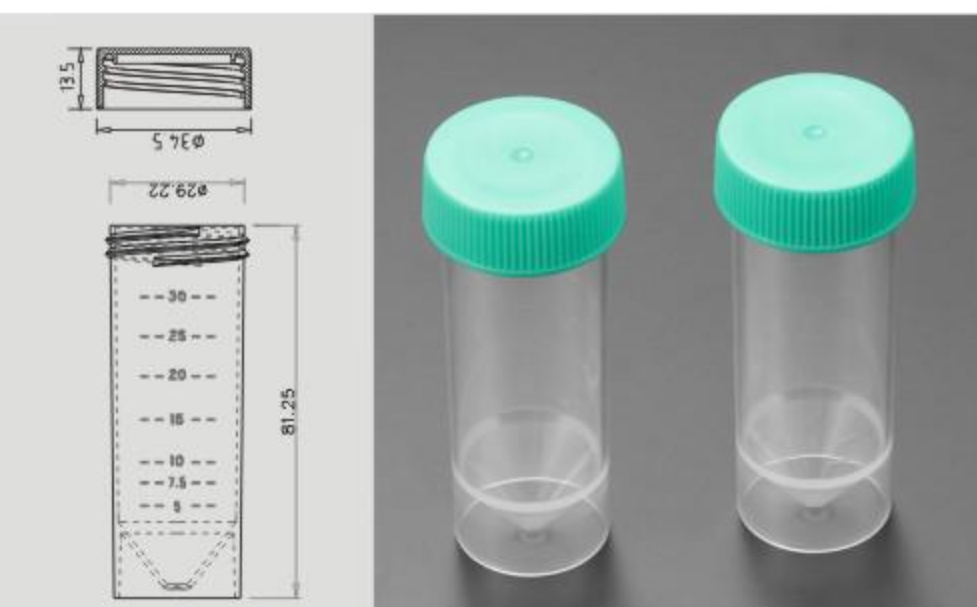

## 30ml Centrifuge tubes

Product Description

- \* Engraved graduation ensure accuracy
- \* Max RCF up to 7,500xg
- \* Autoclavable at 121°C and freezable to -80°C
- \* Sterilized by Gamma irradiation
- \* Certified DNase/RNase Free and Non-pyrogenic
- \* Leak-proof

Cat.No	Capacity(ml)	Bottom	Sterile	Package	Qty. per bag/case
CFT001030	30	Self-standing	Y	Re-sealable bag	50/500
CFT011030	30	Self-standing	N	Re-sealable bag	50/500
CFT000030	30	Self-standing	N	Re-sealable bag caps: 500/bag Tubes: 500/bag	

## 15ml PS Centrifuge Tubes

- \* 15ml PS Centrifuge Tubes
- \* Made with high-quality USP Classic VI polystyrene
- \* Molded graduations stand out distinctly on these optically clear polystyrene tubes
- \* Colorless and transparent are perfect for biological reaction experiments
- \* Engraved graduation at the bottom of each tube
- \* Max RCF up to 3,000xg
- \* Leak-proof
- \* Non-pyrogenic
- \* Available in sterilized or non-sterilized

### Ordering Information

- \* Racked tubes are packaged in environmentally responsible (fully recyclable) chipboard racks or plastic racks
- \* Bagged tubes are packaged in durable and re-sealable (zip closure) bags
- \* Inner packaging is individually labeled for lot-to-lot traceability

Cat.No	Volume(ml)	Material	Bottom	Sterile	Spedality	Package	Qty.per bag/case
CFT410150	15	PS	Conical	N	–	Re-sealable bag	50/500
CFT411150	15	PS	Conical	Y	–	Re-sealable bag	25/500
CFT421150	15	PS	Conical	Y	–	Plastic rack	25/500
CFT412150	15	PS	Conical	Y	DNase-/RNase-free	Re-sealable bag	25/500
CFT422150	15	PS	Conical	Y	DNase-/RNase-free	Plastic rack	25/500
CFT721150	15	PS	Conical	Y	–	Plastic rack	25/300
CFT722150	15	PS	Conical	Y	DNase-/RNase-free	Plastic rack	25/300

## Plastic Centrifuge Tube Racks

PP racks are useful in corrosive environments where commonly used materials tend to crack or corrode. Perfect for supporting tubes during chemical reactions or when storing.

- \* Available with 4 colors: light green, dark green, white and blue
- \* For conical bottom tubes
- \* Made of polypropylen
- \* Marked with numbers for identification
- \* Angular at one end to stack up easily
- \* Autoclavable at 121°C and freezable to -80°C
- \* Can be washed and reused
- \* Available in sterilized or non-sterilized

### Ordering Information

- \* Tubes are packaged in durable and resealable (zip closure) bags
- \* Every bag/case has printed lot No. for quality traceability

Cat.No	Volume(ml)	Sterile	Color	Package	Qty. per bag/case
CFR001015	15	N	Light green	Re-sealable bag	5/50
CFR011015	15	Y	Light green	Re-sealable bag	5/50
CFR002015	15	N	Dark green	Re-sealable bag	5/50
CFR012015	15	Y	Dark green	Re-sealable bag	5/50
CFR003015	15	N	White	Re-sealable bag	5/50
CFR013015	15	Y	White	Re-sealable bag	5/50
CFR004015	15	N	Blue	Re-sealable bag	5/50
CFR014015	15	Y	Blue	Re-sealable bag	5/50
CFR001050	50	N	Light green	Re-sealable bag	5/50
CFR011050	50	Y	Light green	Re-sealable bag	5/50
CFR002050	50	N	Dark green	Re-sealable bag	5/50
CFR012050	50	Y	Dark green	Re-sealable bag	5/50
CFR003050	50	N	White	Re-sealable bag	5/50
CFR013050	50	Y	White	Re-sealable bag	5/50
CFR004050	50	N	Blue	Re-sealable bag	5/50
CFR014050	50	Y	Blue	Re-sealable bag	5/50



## Centrifuge Tube Stand

Centrifuge tube stand with 7 holes is available for 1.5ml, 2.0ml, 15ml, 50ml conical-bottomed centrifuge tube. Perfect for supporting tubes during chemical reactions or when storing.

- \* 3 holes for 1.5ml, 2.0ml micro centrifuge tube, 3 holes for 15ml micro centrifuge tube, and 1 hole for 50 ml micro centrifuge tube
- \* For conical bottom tube
- \* Made of polypropylene
- \* Autoclavable at 121°C and freezable to -80°C
- \* Can be washed and reused
- \* Available in sterilized or non-sterilized

### Ordering Information

- \* Centrifuge Tube Stand is packaged in durable and resealable (zip closure) bags
- \* Every bag/case has printed lot No. for quality traceability

### Product Specifications And Details

Cat.No	Product Description	Sterile	Qty.per. Bag/Case
CTS001001		N	1/50
CTS002001	7 holes, suitable for 1.5ml, 2.0ml micro centrifuge	Y	1/50
CTS001002	tube 15ml, 50ml conical centrifuge tube	N	5/50
CTS002002		Y	5/50



## Conical Centrifuge Bottles

Conical Centrifuge Bottles are popular in samples centrifuging or storage in many research area.

- \* Available with 3 volumes of 225ml, 250ml and 500ml
- \* Made with high-quality gamma resistant polypropylene
- \* Plug seal cap made with polyethylene
- \* Engraved graduation
- \* Max RCF up to 7,500xg
- \* Autoclavable at 121°C and freezable to -196°C
- \* Sterilized by Gamma irradiation
- \* Certified DNase/RNase -free and Non-pyrogenic
- \* Leak-proof



### Ordering Information

- \* Bottles are packaged in durable and re-sealed (zip closure) bags
- \* Inner packaging is individually labelled for lot to lot traceability
- \* All bottles are packaged with caps attached

Cat.No	Capacity(ml)	Size	Bottom	Sterile	Speciality	Qty. per bag/case
CFT012225	225	61x137mm	Conical	Y	RNase & DNase-free and Non-pyro genic	6/48
CFT012250	250	61x161mm	Conical	Y	RNase & DNase-free and Non-pyro genic	6/48
CFT013500	500	95x155mm	Conical	Y	RNase & DNase-free and Non-pyro genic	6/36

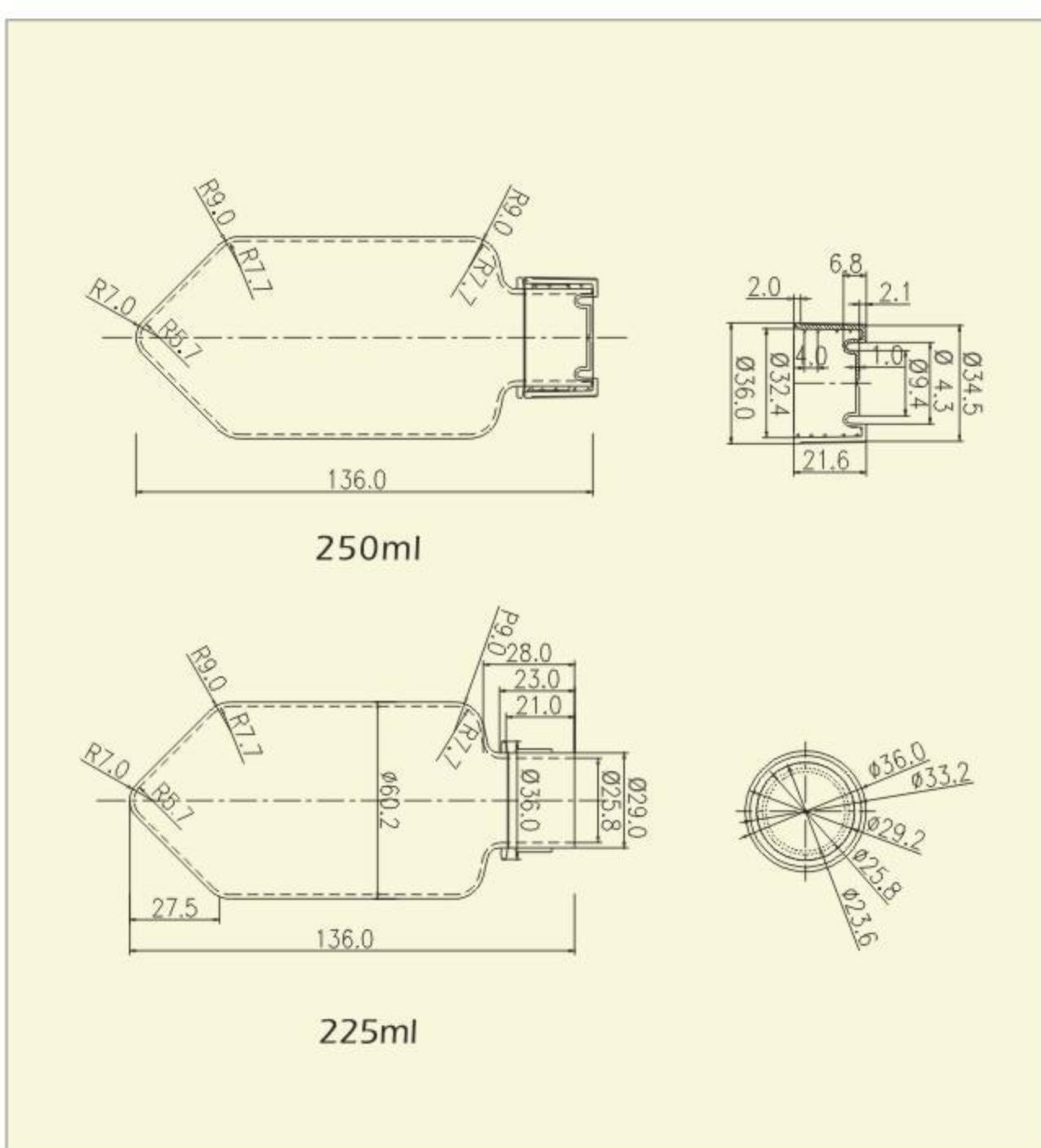

## Easy Flip™ Centrifuge Tubes

- \* Made from high grade gamma resistance polypropylene
- \* One hand easy flip to open the cap
- \* Max. RCF: 9,400xg
- \* Black printed graduations and white writing area can withstand chloroform
- \* Autoclavable at 121°C and freezable to -80°C
- \* Packaged in zip sealed bags or environmental friendly, recyclable paper racks
- \* Leak proof
- \* Gamma irradiation sterilized

### Ordering Information

- \* Racked tubes are packaged in environmentally responsible (fully recyclable) chipboard racks
- \* Bagged tubes are packaged durable and re-sealable (zip closure) bags
- \* Inner packaging is individually labeled for lot-to-lot traceability

Cat.No	Volume(ml)	Description	Package	Qty. per bag/case
CFT211150	15	Conical, Flip top cap, Sterilized	Re-sealable bag	25/500
CFT221150	15	Conical, Flip top cap, Sterilized	Paper rack	50/500
CFT212150	15	Conical, Flip top cap, Sterilized, DNase/RNase free	Re-sealable bag	25/500
CFT222150	15	Conical, Flip top cap, Sterilized, DNase/RNase free	Paper rack	50/500
CFT211500	50	Conical, Flip top cap, Sterilized	Re-sealable bag	25/500
CFT221500	50	Conical, Flip top cap, Sterilized	Paper rack	25/500
CFT212500	50	Conical, Flip top cap, Sterilized, DNase/RNase free	Re-sealable bag	25/500
CFT222500	50	Conical, Flip top cap, Sterilized, DNase/RNase free	Paper rack	25/500

## Easy Flip™ 1.5ml Micro Centrifuge Tubes

- \* Made from high clarity and high grade gamma resistance polypropylene
- \* One hand easy flip to open the cap
- \* Engraved graduation ensure accuracy
- \* Frosted body surface provide easy and legible mark
- \* DNase/RNase free and non-pyrogenic
- \* Suitable for all standard racks and rotors
- \* Boil proof
- \* Maximum rotate speed up to 25,000xg
- \* Autoclavable at 121°C and freezable to -80°C
- \* Available in sterilized or non-sterilized

### Ordering Information

- \* Packaged in durable and re-sealed (zip closure) bags
- \* Every bag has printed lot NO. for quality traceability

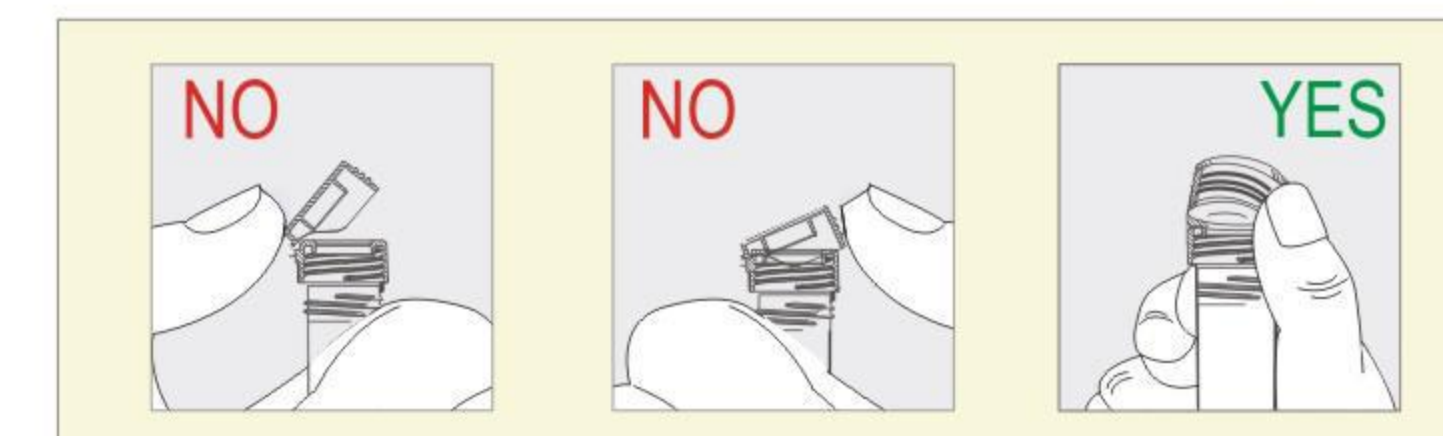
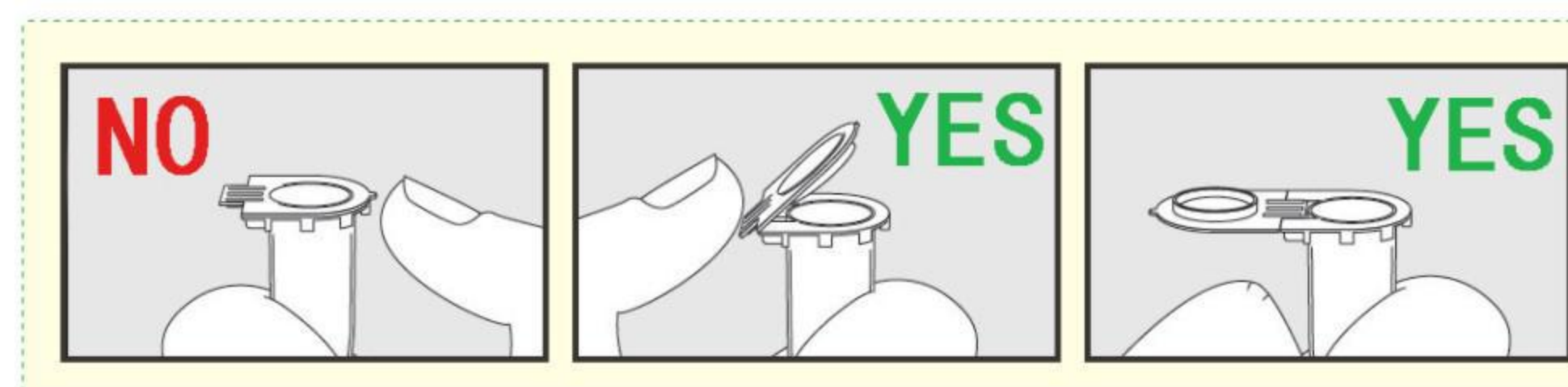

Cat.No	Capacity(ml)	Sterile	Per bag(box)/case
CFT014015	1.5	Y	500/4000
CFT102015	1.5	N	500/4000
CFT103015	1.5	Y	500/4000

### Pestles for 1.5ML Micro Centrifuge Tube

Pestles for 1.5ML micro centrifuge tube are ideal for protein and DNA resuspension as well as grind of soft tissue.

- \* Made of high quality plastic, high hardness, wear resistance
- \* Handle special process design, ease grip
- \* Sterilized by gamma irradiation
- \* Individually wrapped
- \* Non-pyrogenic and DNase/RNase-free

Cat.No	Length(mm)	Description	Sterile	Qty. per pag/case
CSP001002	78	white, individually package	Y	1/100
CSP002002	78	white, bulk package	Y	100/1000
CSP003002	78	white, pestle and microtube combo	Y	1/100

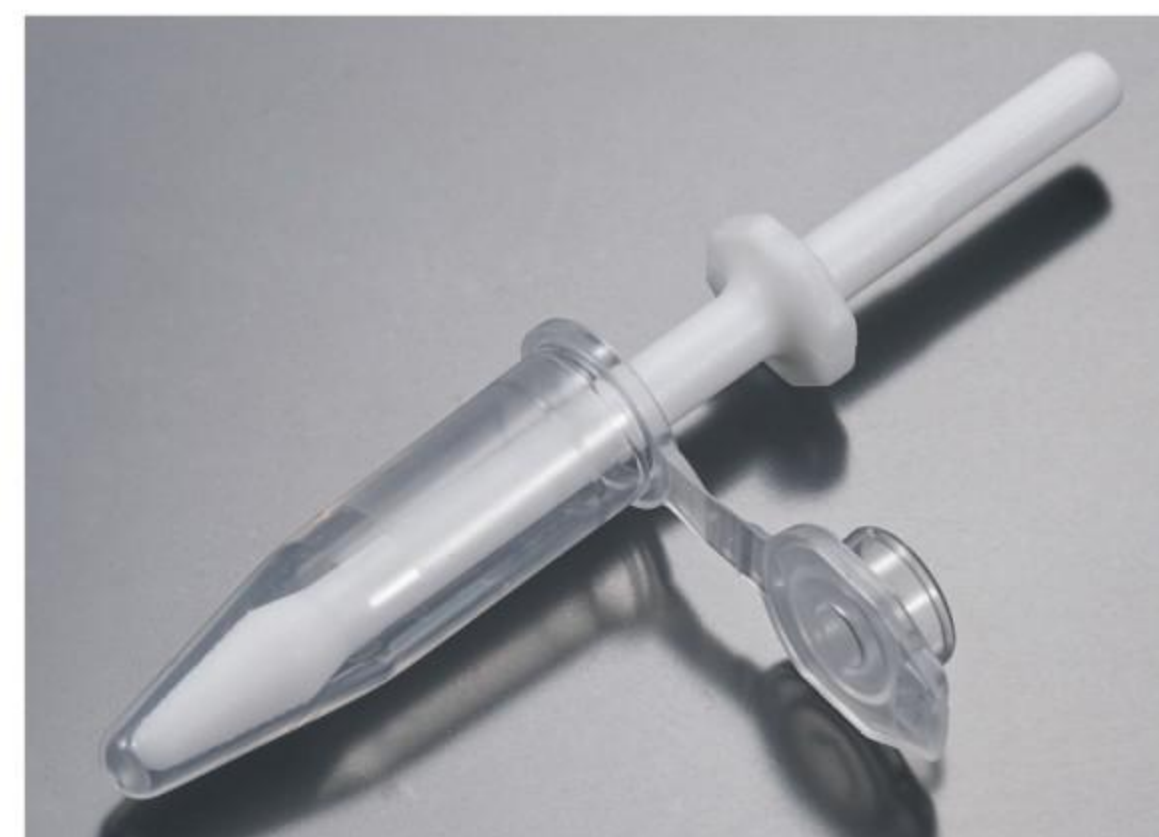

### Micro Centrifuge Tubes

Micro centrifuge tubes are quality products for small samples Centrifuging or storage

- \* Available with 4 volumes of 0.5ml, 1.5ml, 2.0ml and 5.0ml
- \* Engraved graduation ensure accuracy
- \* Flat and frost caps surface together with smooth and frosted body surface
- \* DNase/RNase free and non-pyrogenic
- \* Maximum rotate speed up to 25,000xg
- \* Autoclavable at 121°C and freezable to -80°C



#### Ordering Information

- \* Packaged in easy opening plastic bags
- \* Available in sterilized or non-sterilized
- \* Every bag has printed lot No.quality traceability

### Maximum rotate speed up to 14,000xg

Cat.No	Volume(ml)	Lid	Sterile	Package	Qty. per bag/case
CFT008020	2.0	N	N	Re-sealable bag	1000/15000
CFT108015	1.5	Y	N	Re-sealable bag	50/10000
CFT108020	2.0	Y	N	Re-sealable bag	50/9000



### Micro Centrifuge Without Lid Lock

Cat.No	Capacity(ml)	Color	Sterile	Qty. per bag/case
CTF000005	0.5	Natural	N	1000/8000
CFT000015	1.5	Natural	N	500/4000
CFT000020	2.0	Natural	N	500/4000
CFT000050	5.0	Natural	N	180/1800
CFT022050	5.0	Natural	N	200/4000
CFT023050	5.0	Blue	N	200/4000
CFT024050	5.0	Yellow	N	200/4000
CFT025050	5.0	Green	N	200/4000
CTF026050	5.0	Rose red	N	200/4000
CFT020050	5.0	Black	N	200/4000
CFT010050	5.0	Yellow	N	250/2500
CFT112050	5.0	Black	N	250/2500
CFT001005	5.0	Natural	Y	1000/8000
CFT001015	1.5	Natural	Y	500/4000
CFT001020	2.0	Natural	Y	500/4000
CFT000050	5.0	Natural	N	180/1800
CFT002050	5.0	Natural	Y	200/4000
CFT003050	5.0	Blue	Y	200/4000
CTF004050	5.0	Green	Y	200/4000
CFT005050	5.0	Yellow	Y	200/4000
CFT006050	5.0	Rose red	Y	200/4000
CFT021050	5.0	Black	Y	200/4000
CFT011050	5.0	Yellow	Y	250/2500

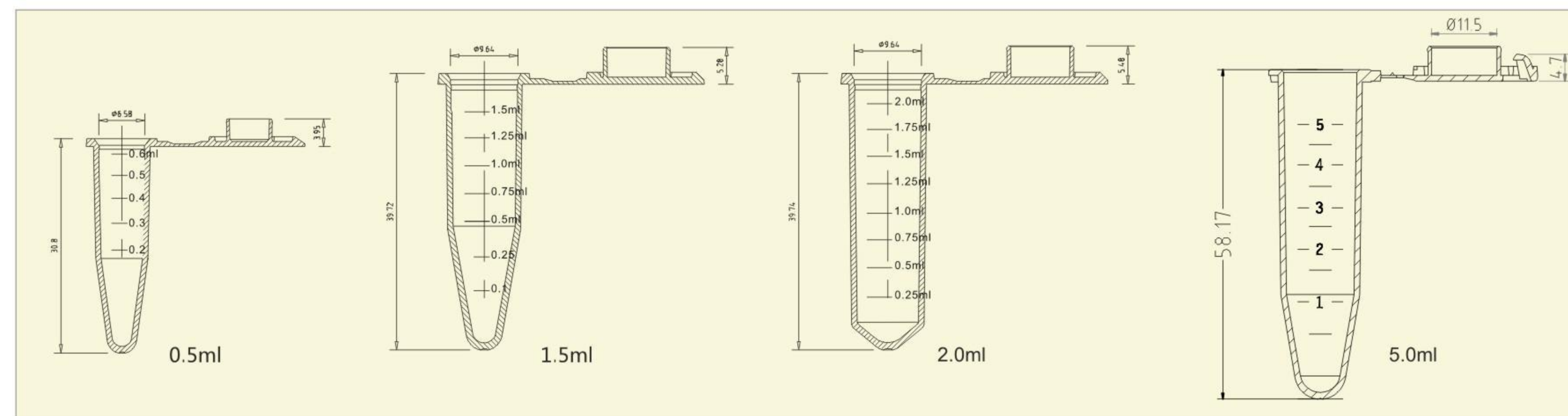



### Micro Centrifuge Tube With Lid Lock

Cat.No	Capacity(ml)	Color	Sterile	Qty. per bag/case
CFT010005	0.5	Natural	N	1000/8000
CFT010015	1.5	Natural	N	500/4000
CFT020015	1.5	Brown	N	500/4000
CFT010020	2.0	Natural	N	500/4000
CFT122050	5.0	Natural	N	200/4000
CFT123050	5.0	Blue	N	200/4000
CFT124050	5.0	Yellow	N	200/4000
CFT125050	5.0	Green	N	200/4000
CTF126050	5.0	Rose red	N	200/4000
CFT127050	5.0	Black	N	200/4000
CFT110050	5.0	Yellow	N	250/2500
CFT112050	5.0	Black	N	250/2500
CFT001105	0.5	Natural	Y	1000/8000
CFT011015	1.5	Natural	Y	500/4000
CFT021015	1.5	Brown	Y	500/4000
CFT011020	2.0	Natural	Y	500/4000
CFT322050	5.0	Natural	Y	200/4000
CFT323050	5.0	Blue	Y	200/4000
CFT324050	5.0	Yellow	Y	200/4000
CFT325050	5.0	Green	Y	200/4000
CFT326050	5.0	Rose red	Y	200/4000
CFT327050	5.0	Black	Y	200/4000
CFT210050	5.0	Yellow	Y	250/2500
CFT212050	5.0	Black	Y	250/2500

### Screw Cap™ Micro Centrifuge Tubes

Cat.No	Capacity(ml)	Color	Spedality	Sterile	Cap	Qty. per bag/case
CFT002005	0.5	Natural	Conical	N	N	500/5000
CFT003005	0.5	Natural	Conical	Y	Y	500/5000
CFT004005	0.5	Natural	Self-standing	N	N	500/5000
CFT005005	0.5	Natural	Self-standing	Y	Y	500/5000
CFT005015	1.5	Natural	Conical	N	N	500/5000
CFT006015	1.5	Natural	Conical	Y	Y	500/5000
CFT007015	1.5	Natural	Self-standing	N	N	500/5000
CFT008015	1.5	Natural	Self-standing	Y	Y	500/5000
CFT002020	2.0	Natural	Conical	N	N	500/5000
CFT003020	2.0	Natural	Conical	Y	Y	500/5000
CFT004020	2.0	Natural	Self-standing	N	N	500/5000
CFT005020	2.0	Natural	Self-standing	Y	Y	500/5000



## Filtration Products



### Syringe Driven Filters

Syringe driven filters are widely used in laboratory, which are easy to operate, safe and effective.

- \* Syringe driven filters are widely used in laboratory, which are easy to operate, safe and effective
- \* Available with 7 membrane types of CA, PVDF, PES, MCE, Nylon, PTFE and SFCA
- \* 3 membrane areas of 0.88cm<sup>2</sup>, 3.46cm<sup>2</sup> and 4.45cm<sup>2</sup>
- \* 3 pore sizes: 0.10µm, 0.22µm and 0.45µm
- \* Quality tested for filter efficacy and housing integrity
- \* Low hold-up volume
- \* Gamma radiation sterilized
- \* Non-pyrogenic

### Ordering Information

- \* Individually packed in peel to open paper/plastic blister pack
- \* Designed recycle paper package box for easy open and close or place
- \* Every package box is labeled with lot Number for quality traceability

Membrane Material	Housing Diameter(mm)	Filter Area(cm <sup>2</sup> )	Housing Material	Hold-up Volume(ml)
PVDF	13.0	0.88	PP	<10
	25.0	3.46	PP	<100
	30.0	4.45	PP	<100
PES	13.0	0.88	PP	<10
	25.0	3.46	PP	<100
	30.0	4.45	PP	<100
MCE	13.0	0.88	PP	<10
	25.0	3.46	PP	<100
	30.0	4.45	PP	<100
NYLON	13.0	0.88	PP	<10
	25.0	3.46	PP	<100
	30.0	4.45	PP	<100
PTFE	13.0	0.88	PP	<10
	25.0	3.46	PP	<100
	30.0	4.45	PP	<100
CA	13.0	0.88	PP	<10
	25.0	3.46	PP	<100
	30.0	4.45	PP	<100
SFCA	13.0	0.88	PP	<10
	25.0	3.46	PP	<100
	30.0	4.45	PP	<100

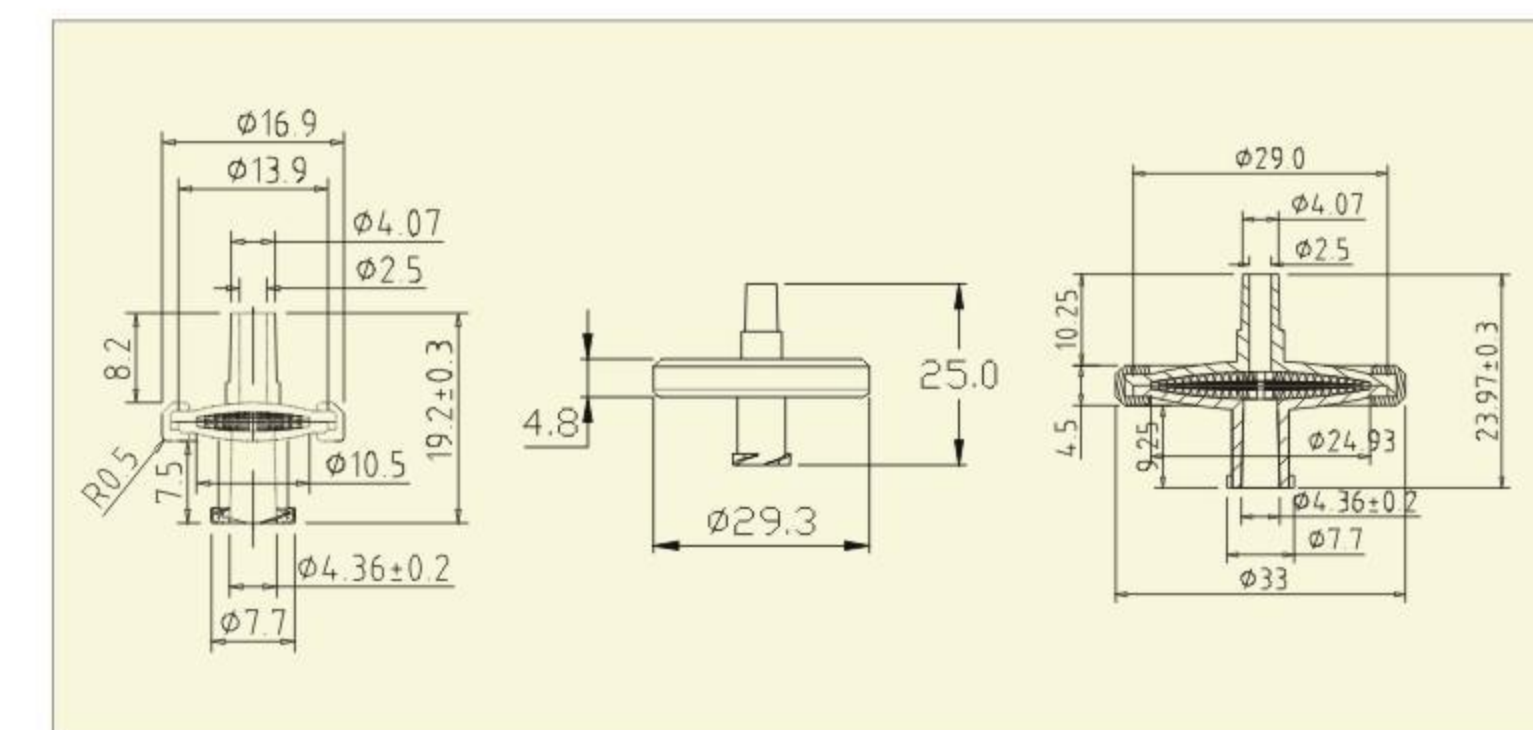

**Individually Package, Sterile**

Cat.No	Membrane Material	Pore Size (µm)	Housing Diameter(mm)	Sterile	Qty. per box/case
FMC201013	MCE	0.22	13.0	Y	100/800
FMC201025		0.22	25.0	Y	45/360
FMC201030		0.22	30.0	Y	45/360
FMC401013		0.45	13.0	Y	100/800
FMC401025		0.45	25.0	Y	45/360
FMC401030		0.45	30.0	Y	45/360
FPV103013	PVDF	0.10	13.0	Y	100/800
FPV103025		0.10	25.0	Y	45/360
FPV103030		0.10	30.0	Y	45/360
FPV203013		0.22	13.0	Y	100/800
FPV203025		0.22	25.0	Y	45/360
FPV203030		0.22	30.0	Y	45/360
FPV403013	PTFE	0.45	13.0	Y	100/800
FPV403025		0.45	25.0	Y	45/360
FPV403030		0.45	30.0	Y	45/360
PTF205013		0.22	13.0	Y	100/800
PTF205030		0.22	25.0	Y	45/360
PTF205030		0.22	30.0	Y	45/360
PTF405013	Nylon	0.45	13.0	Y	100/800
PTF405025		0.45	25.0	Y	45/360
PTF405030		0.45	30.0	Y	45/360
FNY202013		0.22	13.0	Y	100/800
FNY202025		0.22	25.0	Y	45/360
FNY202030		0.22	30.0	Y	45/360
FNY402013	PES	0.45	13.0	Y	100/800
FNY402025		0.45	25.0	Y	45/360
FNY402030		0.45	30.0	Y	45/360
FPE104013		0.1	13.0	Y	100/800
FPE104025		0.1	25.0	Y	45/360
FPE104030		0.1	30.0	Y	45/360
FPE204013	CA	0.22	13.0	Y	100/800
FPE204025		0.22	25.0	Y	45/360
FPE204030		0.22	30.0	Y	45/360
FPE404013		0.45	13.0	Y	100/800
FPE404025		0.45	25.0	Y	45/360
FPE404030		0.45	30.0	Y	45/360
FCA206013	SFCA	0.22	13.0	Y	100/800
FCA206025		0.22	25.0	Y	45/360
FCA206030		0.22	30.0	Y	45/360
FCA406013		0.45	13.0	Y	100/800
FCA406025		0.45	25.0	Y	45/360
FCA406030		0.45	30.0	Y	45/360
SCA207013	SFCA	0.22	13.0	Y	100/800
SCA207025		0.22	25.0	Y	45/360
SCA207030		0.22	30.0	Y	45/360
SCA407013		0.45	13.0	Y	100/800
SCA407025		0.45	25.0	Y	45/360
SCA407030		0.45	30.0	Y	45/360

**Bulk Package, Sterile**

Cat.No	Membrane Material	Pore Size (µm)	Housing Diameter(mm)	Sterile	Qty. per box/case
FMC211013	MCE	0.22	13.0	Y	100/1000
FMC211025		0.22	25.0	Y	50/500
FMC211030		0.22	30.0	Y	50/500
FMC411013		0.45	13.0	Y	100/1000
FMC411025		0.45	25.0	Y	50/500
FMC411030		0.45	30.0	Y	50/500
FPV113013	PVDF	0.10	13.0	Y	100/1000
FPV113025		0.10	25.0	Y	50/500
FPV113030		0.10	30.0	Y	50/500
FPV213013		0.22	13.0	Y	100/1000
FPV213025		0.22	25.0	Y	50/500
FPV213030		0.22	30.0	Y	50/500
FPV413013	PTFE	0.45	13.0	Y	100/1000
FPV413025		0.45	25.0	Y	50/500
FPV413030		0.45	30.0	Y	50/500
PTF215013		0.22	13.0	Y	100/1000
PTF215025		0.22	25.0	Y	50/500
PTF215030		0.22	30.0	Y	50/500
PTF415013	Nylon	0.45	13.0	Y	100/1000
PTF415025		0.45	25.0	Y	50/500
PTF415030		0.45	30.0	Y	50/500
FNY212013		0.22	13.0	Y	100/1000
FNY212025		0.22	25.0	Y	50/500
FNY212030		0.22	30.0	Y	50/500
FNY412013	PES	0.45	13.0	Y	100/1000
FNY412025		0.45	25.0	Y	50/500
FNY412030		0.45	30.0	Y	50/500
FPE114013		0.1	13.0	Y	100/1000
FPE114025		0.1	25.0	Y	50/500
FPE114030		0.1	30.0	Y	50/500
FPE214013	CA	0.22	13.0	Y	100/1000
FPE214025		0.22	25.0	Y	50/500
FPE214030		0.22	30.0	Y	50/500
FPE414013		0.45	13.0	Y	100/1000
FPE414025		0.45	25.0	Y	50/500
FPE414030		0.45	30.0	Y	50/500
FCA216013	SFCA	0.22	13.0	Y	100/1000
FCA216025		0.22	25.0	Y	50/500
FCA216030		0.22	30.0	Y	50/500
FCA416013		0.45	13.0	Y	100/1000
FCA416025		0.45	25.0	Y	50/500
FCA416030		0.45	30.0	Y	50/500
SCA217013	SFCA	0.22	13.0	Y	100/1000
SCA217025		0.22	25.0	Y	50/500
SCA217030		0.22	30.0	Y	50/500
SCA417013		0.45	13.0	Y	100/1000
SCA417025		0.45	25.0	Y	50/500
SCA417030		0.45	30.0	Y	50/500

**Bulk Package, Non-Sterile**

Cat.No	Membrane Material	Pore Size (µm)	Housing Diameter(mm)	Sterile	Qty. per box/case
FMC221013	MCE	0.22	13.0	N	100/1000
FMC221025		0.22	25.0	N	50/500
FMC221030		0.22	30.0	N	50/500
FMC421013		0.45	13.0	N	100/1000
FMC421025		0.45	25.0	N	50/500
FMC421030		0.45	30.0	N	50/500
FPV123013	PVDF	0.10	13.0	N	100/1000
FPV123025		0.10	25.0	N	50/500
FPV123030		0.10	30.0	N	50/500
FPV223013		0.22	13.0	N	100/1000
FPV223025		0.22	25.0	N	50/500
FPV223030		0.22	30.0	N	50/500
FPV423013	PTFE	0.45	13.0	N	100/1000
FPV423025		0.45	25.0	N	50/500
FPV423030		0.45	30.0	N	50/500
PTF225013		0.22	13.0	N	100/1000
PTF225025		0.22	25.0	N	50/500
PTF225030		0.22	30.0	N	50/500
PTF425013	Nylon	0.45	13.0	N	100/1000
PTF425025		0.45	25.0	N	50/500
PTF425030		0.45	30.0	N	50/500
FNY222013		0.22	13.0	N	100/1000
FNY222025		0.22	25.0	N	50/500
FNY222030		0.22	30.0	N	50/500
FNY422013	PES	0.45	13.0	N	100/1000
FNY422025		0.45	25.0	N	50/500
FNY422030		0.45	30.0	N	50/500
FPE124013		0.1	13.0	N	100/1000
FPE124025		0.1	25.0	N	50/500
FPE124030		0.1	30.0	N	50/500
FPE224013	CA	0.22	13.0	N	100/1000
FPE224025		0.22	25.0	N	50/500
FPE224030		0.22	30.0	N	50/500
FPE424013		0.45	13.0	N	100/1000
FPE424025		0.45	25.0	N	50/500
FPE424030		0.45	30.0	N	50/500
FCA226013	SFCA	0.22	13.0	N	100/1000
FCA226025		0.22	25.0	N	50/500
FCA226030		0.22	30.0	N	50/500
FCA426013		0.45	13.0	N	100/1000
FCA426025		0.45	25.0	N	50/500
FCA426030		0.45	30.0	N	50/500
SCA417013	SFCA	0.22	13.0	N	100/1000
SCA417025		0.22	25.0	N	50/500
SCA417030		0.22	30.0	N	50/500
SCA417013		0.45	13.0	N	100/1000
SCA417025		0.45	25.0	N	50/500
SCA417030		0.45	30.0	N	50/500

**Syringe Driven Filters(50mm)**

The 50mm needle filter housing is made of polypropylene (PP), polytetrafluoroethylene (PTFE) membrane, no surfactant, one bi-directional membrane support and Luer lock (diameter 15/25 mm) or ladder The barb (50 mm diameter) inlet/outlet ensures a secure loading of the syringe.

**Product Description**

- ★ Each filter is printed with filter type and aperture to facilitate traceability of the product;
- ★ It is especially suitable for gas sterilization, sterile container ventilation and organic solution sterilization or clarification.
- ★ The products are sterilized by gamma rays, non-pyrogenic and non-cytotoxic.

**Pipette Micro Tips (Reloading Rack)**

**Individually Package, Sterile**

Cat.No	Membrane Material	Pore Size(µm)	Housing Diameter(mm)	Sterile	Qty.per box/case
PTF245050	PTEE	0.22	50.0	Y	1/150
PTF445050		0.45	50.0	Y	1/150
PTF255050	PTEE	0.22	50.0	Y	1/150
PTF455050		0.45	50.0	Y	1/150

**Rack Box**

Cat.No	Membrane Material	Pore Size(µm)	Housing Diameter(mm)	Sterile	Qty.per box/case
PTF225050	PTEE	0.22	50.0	N	10/200
PTF425050		0.45	50.0	N	10/200
PTF235050	PTEE	0.22	50.0	N	20/240
PTF435050		0.45	50.0	N	20/240



**Cell factory accessories**

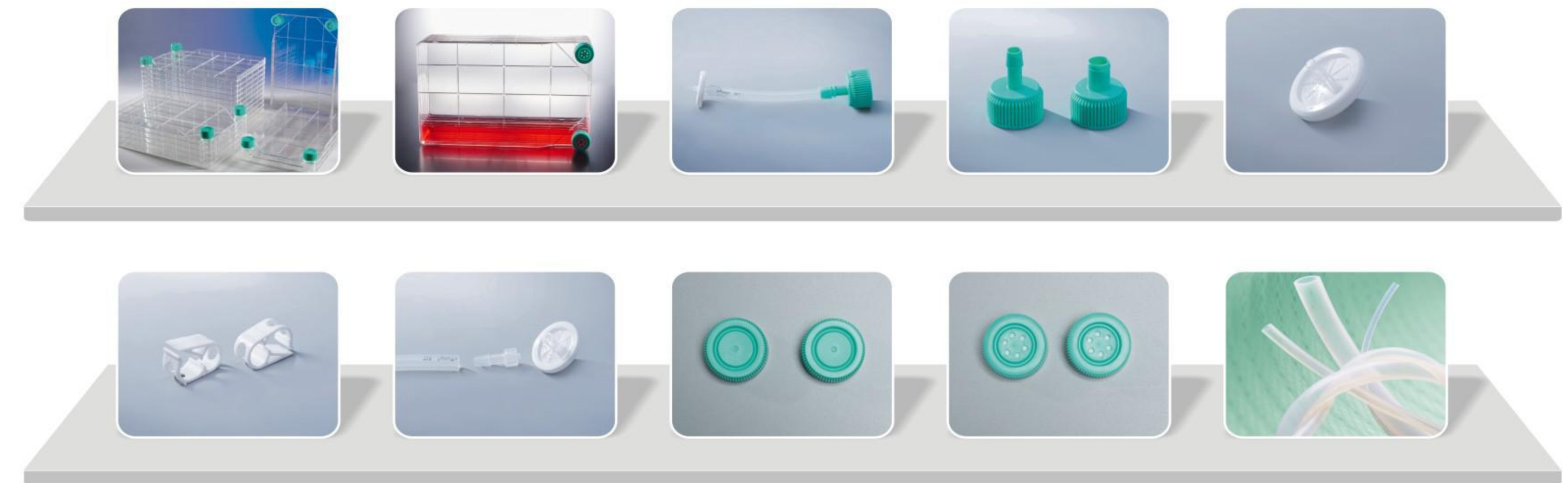

## Vacuum Filtration

Vacuum filters are very useful in large volume samples separation and purification.

- ★ Available with 5 membrane sorts of PVDF, PES, MCE, Nylon and CA
- ★ 3 membrane pore sizes of 0.10µm, 0.22µm and 0.45µm
- ★ 4 volumes size of 150, 250, 500 and 1000ml
- ★ Light weight and heavy wall construction
- ★ Large knurls on the reservoir bottle cap for easy screw
- ★ Designed wide and easy access bottle mouth for efficiently and stably pour out
- ★ Engraved graduation ensure veracity
- ★ Ergonomically designed sidewalls and collar can simplify tightening/loosening and adjustments
- ★ Designed hose connector can fit multiplicate hose diameters
- ★ Non-pyrogenic
- ★ Gamma irradiation sterilied

### Ordering Information

- ★ Vacuum packaged in easy tear-to-open plastic bag and receiver bottle cap is individually wrapped
- ★ Each individual unit is lot-numbered for easy identification and tracking

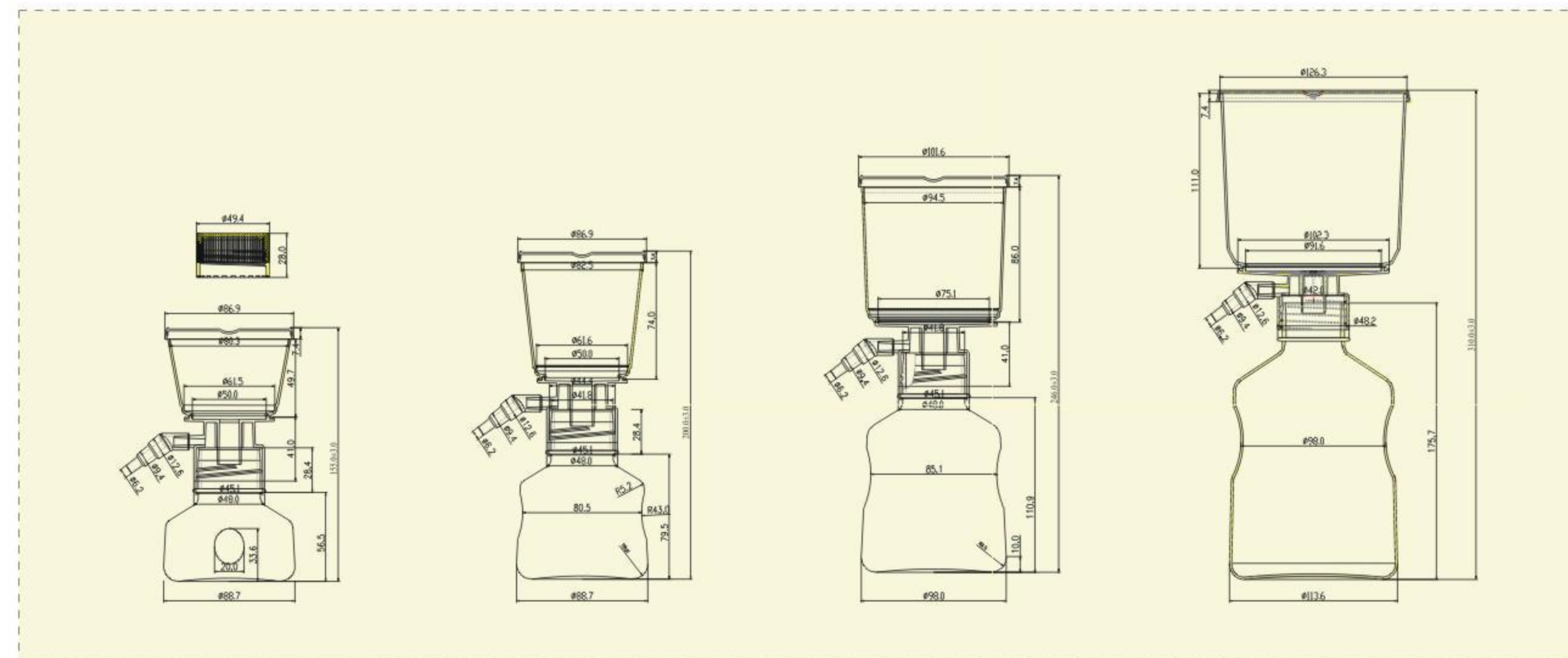

Housing Material	Filter Upper Cup Capacity(ml)	Full Unit Overall Height	Filter Diameter(mm)	Working Volume(ml)	Hold-up Volume (ml)	Linker and Cap Material	Fitting Outlet(mm)	Maximum Operating Temperature (°C)
ABS	150	156	50	150	3	PP	45	45
ABS	250	200	50	250	3	PP	45	45
ABS	500	245	75	500	3	PP	45	45
ABS	1000	310	91	1000	3	PP	45	45

## Disposable Filtration Products

**JET BIOFIL<sup>®</sup>** Laboratory Filtration Products series, including syringe Driven Filters and Vacuum Filtration, are designed specifically for the filtration of culture media and organic solvents in research and industrial laboratories. They are purpose-built with features designed to bring the highest levels of performance and purity to your research. A variety of membrane types and membrane areas can be choosed that offer the wide applicability range for separation and purification of most liquid samples to meet different laboratory needs. The filtration products should be driven by syringes or vacuum pumps. All the produces are manufactured with high quality material (ABS, PP or GPPS) and by proficented technique, which assure them can work under pressure and still hold integrity.

### JET Tips on choosing membrane

#### MCE (Mixed Cellulose Ester)

- ★ By the mixture of nitrocellulose and cellulose acetate, hydrophilic, chemical compatibility, low protein adsorption.
- ★ The use temperature can not be higher than 40°C, the optimum pH range is 3-6.
- ★ Particle analysis, particle removal, biochemical analysis, HPL Csample preparation for general media and aqueous solutions. Can not be used to filter ethanol and alkaline solution.

#### Nylon

Providing a broad range of chemical compatibility of the filtration of either aqueous or organic solvents; hydrophilic; can be used in a broad pH range.

#### PVDF (Polyvinylidene fluoride)

Extremely low protein-binding; for filtration of non-aggressive aqueous and mild organic solutions, or were maximizing protein recovery is important.

#### PES (Polyethersulfone)

Low-affinity for proteins and extractable with substantially faster flow rates than PVDF; suitable for pre-filtration and filtration of buffers and culture media.

#### PTFE (Polytetrafluoroethylene)

Extremly strong chemically resistant and is compatible with various sterilizing methods; ideal for gas and in organic or organic samples in aggressive environments.

#### CA

Lowest binding material available  
Hydrophilic and high throughput  
Strength and dimension stability  
Uniform pore structure

Cat.No	Membrane Material	Pore Size(µm)	Capacity(ml)	Membrane Diameter(mm)	Qty.per box/case	
FPV103150	PVDF	0.1	150	φ50	1/12	
FPV103250		0.1	250	φ50	1/12	
FPV103500		0.1	500	φ75	1/12	
FPV103000		0.1	1000	φ91	1/12	
FPV203150		0.22	150	φ50	1/12	
FPV203250		0.22	250	φ50	1/12	
FPV203500		0.22	500	φ75	1/12	
FPV203000		0.22	1000	φ91	1/12	
FPV403150		0.45	150	φ50	1/12	
FPV403250		0.45	250	φ50	1/12	
FPV403500	0.45	500	φ75	1/12		
FPV403000	0.45	1000	φ91	1/12		
FMC201150	MCE	0.22	150	φ50	1/12	
FMC201250		0.22	250	φ50	1/12	
FMC201500		0.22	500	φ75	1/12	
FMC201000		0.22	1000	φ91	1/12	
FMC401150		0.45	150	φ50	1/12	
FMC401250		0.45	250	φ50	1/12	
FMC401500		0.45	500	φ75	1/12	
FMC401000		0.45	1000	φ91	1/12	
FPE204150		PES	0.22	150	φ50	1/12
FPE204250			0.22	250	φ50	1/12
FPE204500	0.22		500	φ75	1/12	
FPE204000	0.22		1000	φ91	1/12	
FPE404150	0.45		150	φ50	1/12	
FPE404250	0.45		250	φ50	1/12	
FPE404500	0.45		500	φ75	1/12	
FPE404000	0.45		1000	φ91	1/12	
FNY202150	Nylon		0.22	150	φ50	1/12
FNY202250			0.22	250	φ50	1/12
FNY202500		0.22	500	φ75	1/12	
FNY202000		0.22	1000	φ91	1/12	
FNY402150		0.45	150	φ50	1/12	
FNY402250		0.45	250	φ50	1/12	
FNY402500		0.45	500	φ75	1/12	
FNY402000		0.45	1000	φ91	1/12	
FCA206150		CA	0.22	150	φ50	1/12
FCA206250			0.22	250	φ50	1/12
FCA206500	0.22		500	φ75	1/12	
FCA206000	0.22		1000	φ91	1/12	
FCA406150	0.45		150	φ50	1/12	
FCA406250	0.45		250	φ50	1/12	
FCA406500	0.45		500	φ75	1/12	
FCA406000	0.45		1000	φ91	1/12	
FPE234150	PES Express		0.22	150	φ50	1/12
FPE434150			0.45	150	φ50	1/12
FPE234250		0.22	250	φ50	1/12	
FPE434250		0.45	250	φ50	1/12	
FPE234500		0.22	500	φ75	1/12	
FPE434500		0.45	500	φ75	1/12	
FPE234000		0.22	1000	φ91	1/12	
FPE434000		0.45	1000	φ91	1/12	
FPE244250		PES	0.22	250	φ75	1/12
FPE444250			0.45	250	φ75	1/12

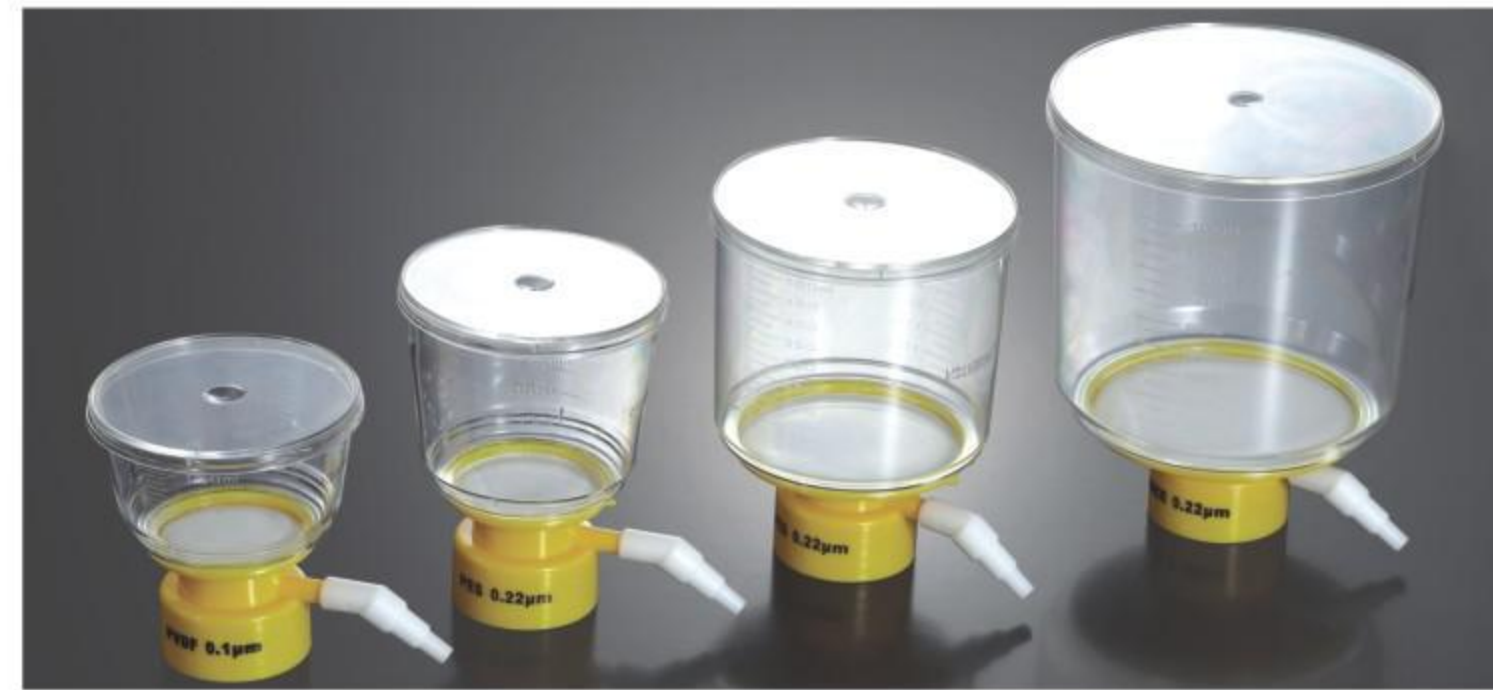

### Filter Upper Cup

Vacuum filters are very useful in large volume samples separation and purification.

- \* Available with 5 membrane sorts of PVDF, PES, MCE, CA and Nylon
- \* 3 membrane pore sizes of 0.10µm, 0.22µm and 0.45µm
- \* 4 volume sizes of 150, 250, 500 and 1000ml
- \* Light weight and heavy wall construction
- \* Designed wide and easy access bottle mouth for efficiently and stably
- \* Non-pyrogenic
- \* Gamma irradiation sterilized

### Ordering Information

- \* Packaged in easy peel-to-open plastic bag, and receiver bottle cap is individually wrapped
- \* Each individual unit is lot-numbered for easy identification

### Reservoir Bottle

Cat.No	Membrane	Material	Capacity(ml)	Sterile	Qty. per bag/case
FRB000150			150	Y	1/24
FRB000250	PS		250	Y	1/24
FRB000500			500	Y	1/24
FRB000000			1000	Y	1/24



Cat.No	Membrane	Material	Pore Size(µm)	Capacity(ml)	Membrane Diameter(mm)	Qty. per bag/case	
FPV113150	PVDF		0.1	150	Φ50	1/24	
FPV113250			0.1	250	Φ50	1/24	
FPV113500			0.1	500	Φ75	1/24	
FPV113000			0.1	1000	Φ91	1/24	
FPV213150			0.22	150	Φ50	1/24	
FPV213250			0.22	250	Φ50	1/24	
FPV213500			0.22	500	Φ75	1/24	
FPV213000			0.22	1000	Φ91	1/24	
PFV413150			0.45	150	Φ50	1/24	
PFV413250			0.45	250	Φ50	1/24	
PFV413500			0.45	500	Φ75	1/24	
PFV413000			0.45	1000	Φ91	1/24	
FMC211150	MCE		0.22	150	Φ50	1/24	
FMC211250			0.22	250	Φ50	1/24	
FMC211500			0.22	500	Φ75	1/24	
FMC211000			0.22	1000	Φ91	1/24	
FMC411150			0.45	150	Φ50	1/24	
FMC411250			0.45	250	Φ50	1/24	
FMC411500			0.45	500	Φ75	1/24	
FMC411000			0.45	1000	Φ91	1/24	
FPE214150	PES		0.22	150	Φ50	1/24	
FPE214250			0.22	250	Φ50	1/24	
PPE214500			0.22	500	Φ75	1/24	
FPE214000			0.22	1000	Φ91	1/24	
FPE414150			0.45	150	Φ50	1/24	
FPE414250			0.45	250	Φ50	1/24	
FPE414500			0.45	500	Φ75	1/24	
FPE414000			0.45	1000	Φ91	1/24	
FNY412150		Nylon		0.45	150	Φ50	1/24
FNY412250				0.45	250	Φ50	1/24
FNY412500				0.45	500	Φ75	1/24
FNY412000				0.45	1000	Φ91	1/24
FCA216150	CA		0.45	150	Φ50	1/24	
FCA216250			0.45	250	Φ50	1/24	
FCA216500			0.45	500	Φ75	1/24	
FCA216000			0.45	1000	Φ91	1/24	
FCA416150			0.22	150	Φ50	1/24	
FCA416250			0.22	250	Φ50	1/24	
FCA416500			0.22	500	Φ75	1/24	
FCA416000			0.22	1000	Φ91	1/24	
FPE254250	PES		0.22	250	Φ75	1/24	
FPE454250			0.45	250	Φ75	1/24	
FPE234150	PES Express		0.22	150	Φ50	1/24	
FPE234250			0.22	250	Φ50	1/24	
FPE234500			0.22	500	Φ75	1/24	
FPE234000			0.22	1000	Φ91	1/24	

## Centrifugal Filters

Cap (HDPE/High-density Polyethylene); Filtration (ABS/Acrylonitrile-Butadiene-Styrene); Tube (PP/Polypropylene); Membrane: Polyethersulfone (PES); Sealing gasket (PE/Polyethylene).

### Purpose

Processing of protein solutions containing biomolecules (albumin, mAbs, IgG, IgM, hormones, growth factors, etc.)

Cat.No	Capacity(ml)	Bottom	Sterile	MWCO(KD)	Cap Color	Qty. per box/case
FTT105500	50	Conical	N	5	White	8/96
FTT205500	50	Conical	N	5	White	24/96
FTT110500	50	Conical	N	10	White	8/96
FTT210500	50	Conical	N	10	White	24/96
FTT130500	50	Conical	N	30	White	8/96
FTT230500	50	Conical	N	30	White	24/96
FTT150500	50	Conical	N	50	White	8/96
FTT250500	50	Conical	N	50	White	24/96
FTT100500	50	Conical	N	100	White	8/96
FTT200500	50	Conical	N	100	White	24/96



- \* Protein Concentration, Nucleic Acid Concentration, Buffer Exchange, Dialysis, Desalting
- \* Dead stop: A voids spinning to dryness, provides a predictable concentration factor and no need to calibrate for several samples to run in parallel. Available in multiple pore sizes with the following defined Molecular Weight Cut-Offs (MWCO): 3.5, 10, 30, 50 and 100KD
- \* Vertical membranes: Aligned with filtrate rather than perpendicular for less clogging, less waste and faster filtration; capable of 25- to 80- fold concentration in a single step
- \* Broad chemical compatibility: Heat-sealed membrane eliminates adhesives and downstream extractables; compatible with pH 1 to 9
- \* Reverse spin recovery: Enables maximum protein recovery without introducing pipetting errors; low binding membrane and polypropylene housing for > 90% sample recovery
- \* Reliable: Spin precious samples with confidence in one robust, sleek unit that prevents leakage. Ultrafiltration membrane is neutrally charged, rendering it low binding for enhanced flux and recovery. The membrane has excellent chemical resistance and very low extractables
- \* Temperature range: -20°C to +50°C
- \* Autoclavability: No
- \* Maximum initial sample volume: Swinging bucket(12.0 ml), Fixed angle rotor(10.0 ml)
- \* Typical final concentrate volume: 200 µl
- \* Maximum relative centrifugal force: Swinging bucket rotor(4,000g), Fixed angle rotor(5,000g)
- \* Active membrane area: 5.48 cm<sup>2</sup>

Dimensions (Unit: mm)

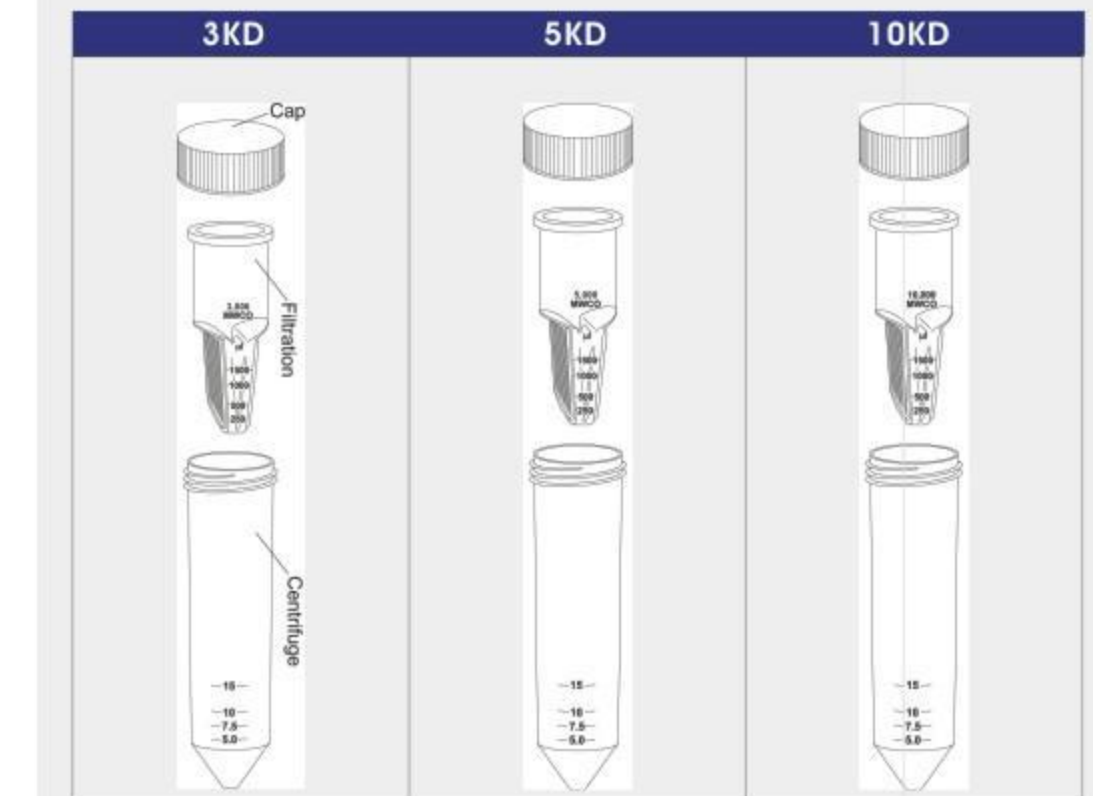

Filter device in tube (capped) Length: 119 mm Diameter: 29.3 mm  
Filter device Length: 72.0 mm Diameter: 29.5 mm

### This membrane is not compatible with the following

- \* Acetic Acid (≥25%)
- \* Acetonitrile (≥30%)
- \* Aliphatic & aromatic esters
- \* Amines
- \* Ammonium hydr oxide (≥5%)
- \* Aromatic & chlorinated hydrocarbons
- \* 6: This membrane is not compatible with the following
- \* Butyl acetate (≥40%)
- \* Dimethyl acetamide (DMAC) (≥30%)
- \* Ethers
- \* Hydrochloric acid (≥0.5N at 50°C)
- \* Isopropyl Alcohol (≥25%)
- \* Ketone
- \* Methylene chloride (≥1%)
- \* Methyl ethyl ketone (≥1%)
- \* Phosphoric acid (≥1N)
- \* Sodium deoxycholate (≥5%)
- \* Sodium hydr oxide (≥0.5N at 50°C)
- \* Sodium hypochlorite (≥0.04%)
- \* Tetrahydrofuran (≥5%)
- \* Toluene (≥1%)





Tube Top Vacuum Filters



Tube Vacuum Filter System

### Tube Top Vacuum Filters

- \* 50mm diameter membrane
- \* 2 pore sizes of 0.22µm, 0.45µm, 5 membrane types of CA, PES, MCE, PVDF and Nylon
- \* Minimize unnecessary transfers by filtering directly into centrifuge tube
- \* Each polypropylene centrifuge tube is supplied with an individually wrapped cap for storage
- \* Gamma radiation sterilized
- \* Non-pyrogenic

Cat.No	Membrane Material	Pore Size(µm)	Funnel/Tube Size(ml)	Sterile	Qty. per bag/case
FCF000001	CA	0.45	150/50	Y	1/24
FCF000002		0.22	150/50	Y	1/24
FCF000003	PES	0.45	150/50	Y	1/24
FCF000004		0.22	150/50	Y	1/24
FCF000005	MCE	0.45	150/50	Y	1/24
FCF000006		0.22	150/50	Y	1/24
FCF000007	PVDF	0.45	150/50	Y	1/24
FCF000008		0.22	150/50	Y	1/24
FCF000009	Nylon	0.45	150/50	Y	1/24
FCF000010		0.22	150/50	Y	1/24

### Tube Vacuum Filter System(including tube, cap and stand)

Cat.No	Membrane Material	Pore Size(µm)	Funnel/Tube Size(ml)	Sterile	Qty. per bag/case
FCF010001	CA	0.45	150/50	Y	1/12
FCF010002		0.22	150/50	Y	1/12
FCF010003	PES	0.45	150/50	Y	1/12
FCF010004		0.22	150/50	Y	1/12
FCF010005	MCE	0.45	150/50	Y	1/12
FCF010006		0.22	150/50	Y	1/12
FCF010007	PVDF	0.45	150/50	Y	1/12
FCF010008		0.22	150/50	Y	1/12
FCF010009	Nylon	0.45	150/50	Y	1/12
FCF010010		0.22	150/50	Y	1/12

### Ordering Information

- \* Packaged in resealable bag, and centrifuge tube cap is individually wrapped
- \* Each individual unit is lot-numbered for easy identification and tracking



# Pipette Micro Tips

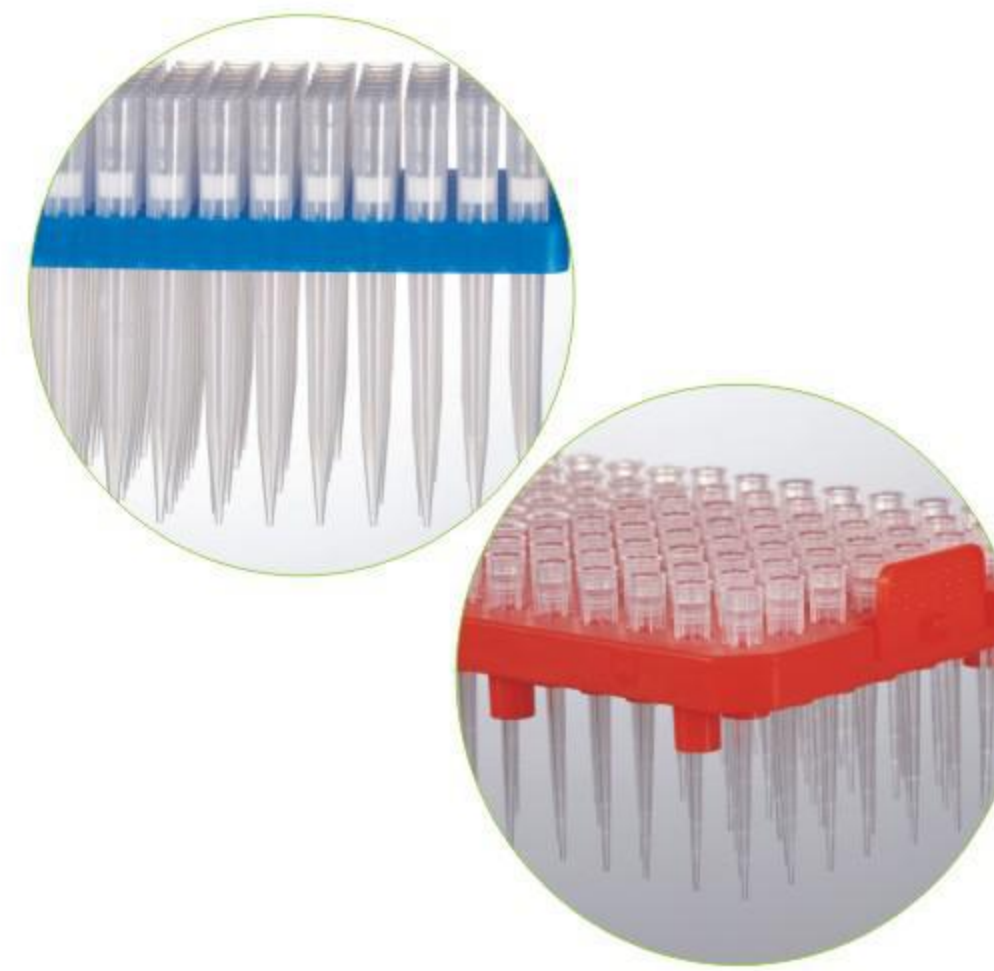

### ZEROTIP® Pipette Micro Tips

JET ZEROTIP® are manufactured from super clear high quality Polypropylene. The surfaces of the tips are produced through a special process. This process makes the tip inner surface become super hydrophobic, thus significantly reduces sample loss and provides substantially higher reproducibility when working with critical media.

- \* Available with 6 transfer volumes of 10µl, 20µl, 100µl, 200µl, 300µl and 1000µl
- \* Free of Nucleic Acids, Pyrogens/Endotoxins, PCR Inhibitors and Trace Metals
- \* Ideal for biological samples that contain detergents such as SDS, Tween Triton 100 ect
- \* Tips with PP filter are also available
- \* Preferred accessories for most brand micropipettor
- \* Fully autoclavable to 121°C
- \* Non-Pyrogenic & DNase/RNase-free
- \* Available in gamma irradiation sterilized or non-sterilized



### Ordering Information

- \* Every rack or case is printed with lot No. for quality traceability
- \* Packaged in economical re-sealable plastic bags or extra-rigid autoclavable racks

### 10µl Tips

Cat.No	Capacity(µl)	Color	Filter	Sterile	Packaging	Qty. per bag or box/case
PMT010010	10	Natural	N	N	Re-sealable bag	1000/10000
PMT011010	10	Natural	N	Y	Re-sealable bag	1000/10000
PMT110010	10	Natural	Y	N	Re-sealable bag	1000/10000
PMT111010	10	Natural	Y	Y	Re-sealable bag	1000/10000
PMT250010	10	Natural	N	N	Rack box	96/1920
PMT251010	10	Natural	N	Y	Rack box	96/1920
PMT550010	10	Natural	Y	N	Rack box	96/1920
PMT252010	10	Natural	Y	Y	Rack box	96/1920
PMT950010	10	Natural	N	N	Reloading Rack	960/9600
PMT611010	10	Natural	N	Y	Re-sealable bag	96/1920
PMT711010	10	Natural	Y	Y	Re-sealable bag	96/1920

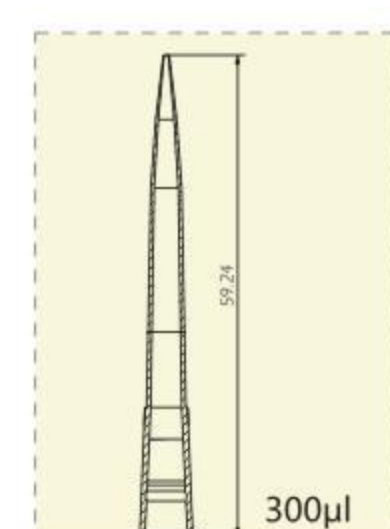
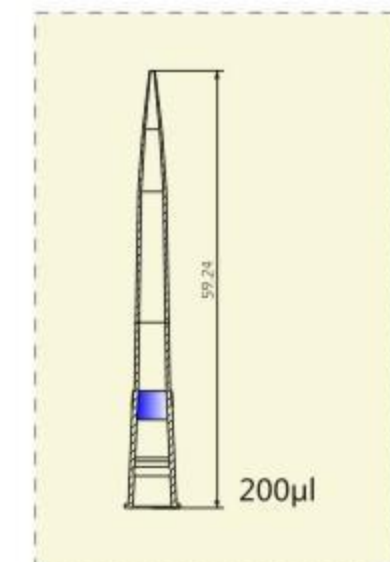
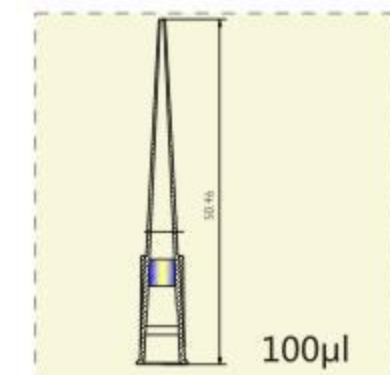
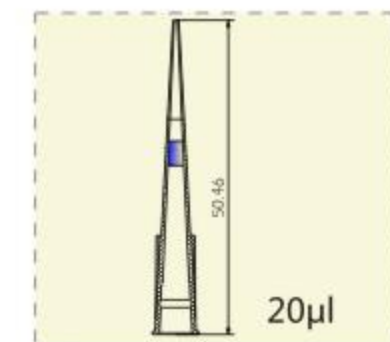
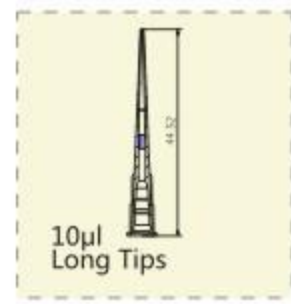
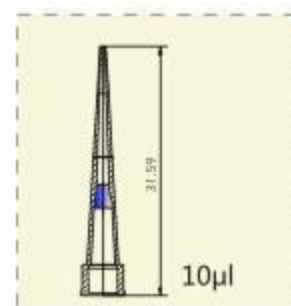

### 10µl Long Tips

Cat.No	Capacity(µl)	Color	Filter	Sterile	Packaging	Qty. per bag or box/case
PMT030010	10	Natural	N	N	Re-sealable bag	1000/10000
PMT031010	10	Natural	N	Y	Re-sealable bag	1000/10000
PMT130010	10	Natural	Y	N	Re-sealable bag	1000/10000
PMT131010	10	Natural	Y	Y	Re-sealable bag	1000/10000
PMT230010	10	Natural	N	N	Rack box	96/1920
PMT231010	10	Natural	N	Y	Rack box	96/1920
PMT232010	10	Natural	Y	N	Rack box	96/1920
PMT233010	10	Natural	Y	Y	Rack box	96/1920
PMT631010	10	Natural	N	Y	Re-sealable bag	96/1920
PMT731010	10	Natural	Y	Y	Re-sealable bag	96/1920

### 20µl Tips

Cat.No	Capacity(µl)	Color	Filter	Sterile	Packaging	Qty. per bag or box/case
PMT110020	20	Natural	Y	N	Re-sealable bag	1000/10000
PMT111020	20	Natural	Y	Y	Re-sealable bag	1000/10000
PMT250020	20	Natural	Y	N	Rack box	96/1920
PMT252020	20	Natural	Y	Y	Rack box	96/1920
PMT711020	20	Natural	Y	Y	Re-sealable bag	96/1920

### 100µl Tips

Cat.No	Capacity(µl)	Color	Filter	Sterile	Packaging	Qty. per bag or box/case
PMT110100	100	Natural	Y	N	Re-sealable bag	1000/10000
PMT111100	100	Natural	Y	Y	Re-sealable bag	1000/10000
PMT250100	100	Natural	Y	N	Rack box	96/1920
PMT252100	100	Natural	Y	Y	Rack box	96/1920
PMT711100	100	Natural	Y	Y	Re-sealable bag	96/1920

### 200µl Tips

Cat.No	Capacity(µl)	Color	Filter	Sterile	Packaging	Qty. per bag or box/case
PMT010200	200	Natural	N	N	Re-sealable bag	1000/10000
PMT011200	200	Natural	N	Y	Re-sealable bag	1000/10000
PMT012200	200	Natural	Y	N	Re-sealable bag	1000/10000
PMT111200	200	Natural	Y	Y	Re-sealable bag	1000/10000
PMT250200	200	Natural	N	N	Rack box	96/1920
PMT251200	200	Natural	N	Y	Rack box	96/1920
PMT230200	200	Natural	Y	N	Rack box	96/1920
PMT231200	200	Natural	Y	Y	Rack box	96/1920
PMT950200	200	Natural	N	N	Reloading Rack	960/9600
PMT951200	200	Yellow	N	N	Reloading Rack	960/9600
PMT611200	200	Natural	N	Y	Re-sealable bag	96/1920
PMT711200	200	Natural	Y	Y	Re-sealable bag	96/1920

### 300µl Tips

Cat.No	Capacity(µl)	Color	Filter	Sterile	Packaging	Qty. per bag or box/case
PMT030300	300	Natural	N	N	Re-sealable bag	1000/10000
PMT031300	300	Natural	N	Y	Re-sealable bag	1000/10000
PMT130300	300	Natural	Y	N	Re-sealable bag	1000/10000
PMT131300	300	Natural	Y	Y	Re-sealable bag	1000/10000
PMT230300	300	Natural	N	N	Rack box	96/1920
PMT231300	300	Natural	N	Y	Rack box	96/1920
PMT232300	300	Natural	Y	N	Rack box	96/1920
PMT233300	300	Natural	Y	Y	Rack box	96/1920
PMT950300	300	Natural	N	N	Reloading Rack	960/9600
PMT631300	300	Natural	N	Y	Re-sealable bag	96/1920
PMT731300	300	Natural	Y	Y	Re-sealable bag	96/1920

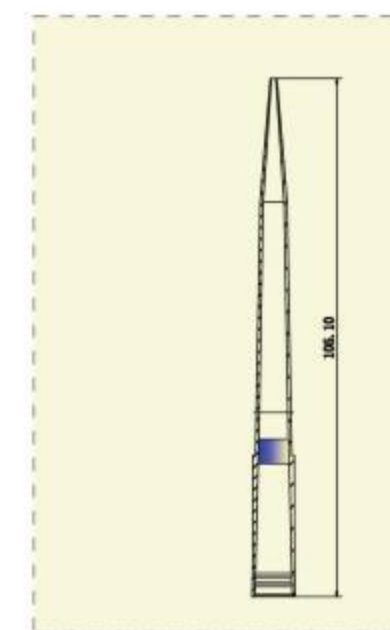
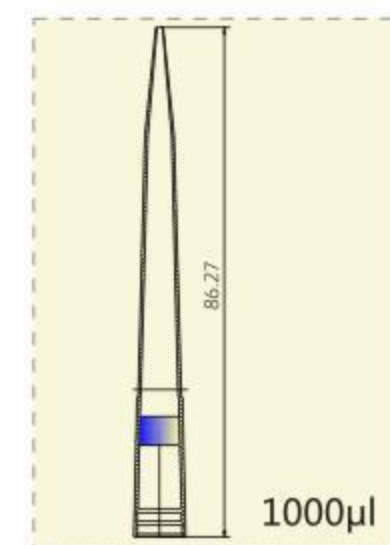

### 1000µl Tips

Cat.No	Capacity(µl)	Color	Filter	Sterile	Packaging	Qty. per bag or box/case
PMT010000	1000	Natural	N	N	Re-sealable bag	1000/10000
PMT011000	1000	Natural	N	Y	Re-sealable bag	1000/10000
PMT110000	1000	Natural	Y	N	Re-sealable bag	1000/10000
PMT111000	1000	Natural	Y	Y	Re-sealable bag	1000/10000
PMT250000	1000	Natural	N	N	Rack box	96/1920
PMT251000	1000	Natural	N	Y	Rack box	96/1920
PMT550000	1000	Natural	Y	N	Rack box	96/1920
PMT252000	1000	Natural	Y	Y	Rack box	96/1920
PMT950000	1000	Natural	N	N	Reloading Rack	480/4800
PMT951000	1000	Bule	N	N	Reloading Rack	480/4800
PMT611000	1000	Natural	N	Y	Re-sealable bag	96/1920
PMT711000	1000	Natural	Y	Y	Re-sealable bag	96/1920

### 1000µl Long Tips

Cat.No	Capacity(µl)	Color	Filter	Sterile	Packaging	Qty. per bag/case
PMT070000	1000	Natural	N	N	Re-sealable bag	1000/10000
PMT071000	1000	Natural	N	Y	Re-sealable bag	1000/10000
PMT170000	1000	Natural	Y	N	Re-sealable bag	1000/10000
PMT171000	1000	Natural	Y	Y	Re-sealable bag	1000/10000
PMT270000	1000	Natural	N	N	Rack box	96/1920
PMT271000	1000	Natural	N	Y	Rack box	96/1920
PMT370000	1000	Natural	Y	N	Rack box	96/1920
PMT371000	1000	Natural	Y	Y	Rack box	96/1920

## Pipette Micro Tips

Pipette Micro Tips are good quality consumable products for micropipettor.

- \* Manufactured from specially high quality polypropylene
- \* Tips with PP filter are also available
- \* Preferred accessories for most brand micropipettor
- \* Available with 6 transfer volumes of 0.1-10µl, 2-20µl, 10-100µl, 20-200µl, 10-300µl and 100-1000µl
- \* Color coded for easy identification
- \* Fully autoclavable to 121°C

### Ordering Information

- \* Every rack or case is printed with lot No. for quality traceability
- \* Packaged in economical re-sealable plastic bags or extra-rigid autoclavable racks
- \* Available in gamma irradiation sterilized or non-sterilized

### Rack of Tips

Cat.No	Volume(µl)	Sterile	Qty. per/case
PPT450010	10	N	20
PPT450100	100	N	20
PPT450200	200	N	20
PPT450000	1000	N	20

### Pipette Micro Tips (Reloading Rack)

Cat.No	Capacity(µl)	Color	Layer Qty.	Filter	Sterile	Packaging	Qty. per bag/case
PPT900010	10	Natural	10	N	N	Reloading Rack	960/9600
PPT900200	200	Natural	10	N	N	Reloading Rack	960/9600
PPT901200	200	Yellow	10	N	N	Reloading Rack	960/9600
PPT900300	300	Natural	10	N	N	Reloading Rack	960/9600
PPT900000	1000	Natural	5	N	N	Reloading Rack	480/4800
PPT901000	1000	Bule	5	N	N	Reloading Rack	480/4800

### Pipette Micro Tips

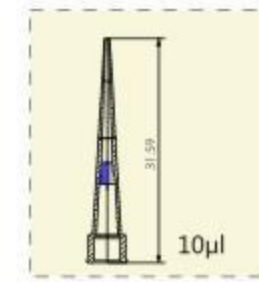

Cat.No	Capacity(µl)	Color	Filter	Sterile	Packaging	Qty.per bag/box	Qty.per case
PPT000010	0.1~10	Natural	N	N	Re-sealable bag	1000	10000
PPT221010	0.1~10	Natural	N	Y	Re-sealable bag	1000	10000
PPT100010	0.1~10	Natural	Y	N	Re-sealable bag	1000	10000
PPT101010	0.1~10	Natural	Y	Y	Re-sealable bag	1000	10000
PPT050010	0.1~10	Natural	N	N	Rack box	96	1920
PPT051110	0.1~10	Natural	N	Y	Rack box	96	1920
PPT150010	0.1~10	Natural	Y	Y	Rack box	96	1920
PPT151010	0.1~10	Natural	Y	Y	Rack box	96	1920

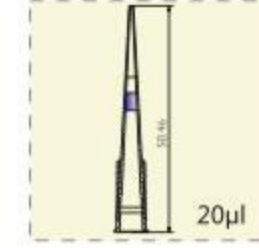

PPT100020	2~20	Natural	Y	N	Re-sealable bag	1000	10000
PPT101020	2~20	Natural	Y	Y	Re-sealable bag	1000	10000
PPT150020	2~20	Natural	Y	N	Rack box	96	1920
PPT151020	2~20	Natural	Y	Y	Rack box	96	1920

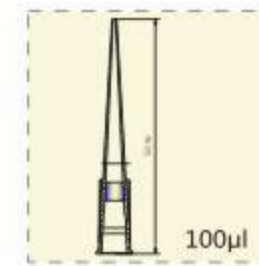

PPT100100	10~100	Natural	Y	N	Re-sealable bag	1000	10000
PPT101100	10~100	Natural	Y	Y	Re-sealable bag	1000	10000
PPT150100	10~100	Natural	Y	N	Rack box	96	1920
PPT151100	10~100	Natural	Y	Y	Rack box	96	1920

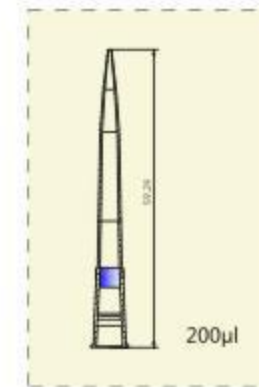

PPT000200	20~200	Natural	N	N	Re-sealable bag	1000	10000
PPT001200	20~200	Natural	N	Y	Re-sealable bag	1000	10000
PPT150200	20~200	Natural	Y	N	Re-sealable bag	1000	10000
PPT151200	20~200	Natural	Y	Y	Re-sealable bag	1000	10000
PPT050200	20~200	Natural	N	N	Rack box	96	1920
PPT051200	20~200	Natural	N	Y	Rack box	96	1920
PPT153200	20~200	Natural	Y	Y	Rack box	96	1920
PPT152200	20~200	Natural	Y	N	Rack box	96	1920

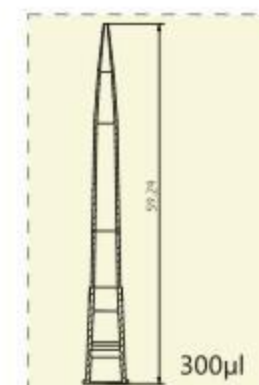

PPT300300	10~300	Natural	N	N	Re-sealable bag	1000	10000
PPT301300	10~300	Natural	N	Y	Re-sealable bag	1000	10000
PPT402300	10~300	Natural	Y	N	Re-sealable bag	1000	10000
PPT401300	10~300	Natural	Y	Y	Re-sealable bag	1000	10000
PPT350300	10~300	Natural	N	N	Rack box	96	1920
PPT351300	10~300	Natural	N	Y	Rack box	96	1920
PPT450300	10~300	Natural	Y	N	Rack box	96	1920
PPT451300	10~300	Natural	Y	Y	Rack box	96	1920

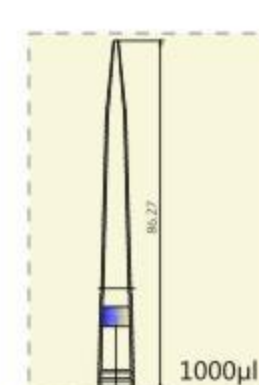

PPT000000	100~1000	Natural	N	N	Re-sealable bag	1000	10000
PPT001000	100~1000	Natural	N	Y	Re-sealable bag	1000	10000
PPT100000	100~1000	Natural	Y	N	Re-sealable bag	1000	10000
PPT101000	100~1000	Natural	Y	Y	Re-sealable bag	1000	10000
PPT050000	100~1000	Natural	N	N	Rack box	96	1920
PPT051000	100~1000	Natural	N	Y	Rack box	96	1920
PPT150000	100~1000	Natural	Y	N	Rack box	96	1920
PPT151000	100~1000	Natural	Y	Y	Rack box	96	1920

### 10µl Long Tips

Cat.No	Capacity(µl)	Color	Filter	Sterile	Packaging	Qty. per case
PPT300010	0.1~10	Natural	N	N	Re-sealable bag	1000/10000
PPT301010	0.1~10	Natural	N	Y	Re-sealable bag	1000/10000
PPT402010	0.1~10	Natural	Y	N	Re-sealable bag	1000/10000
PPT401010	0.1~10	Natural	Y	Y	Re-sealable bag	1000/10000
PPT350010	0.1~10	Natural	N	N	Rack box	96/1920
PPT351010	0.1~10	Natural	N	Y	Rack box	96/1920
PPT450010	0.1~10	Natural	Y	N	Rack box	96/1920

### 1000µl Long Tips

Cat.No	Capacity(µl)	Color	Filter	Sterile	Packaging	Qty. per bag case
PPT070000	1000	Natural	N	N	Re-sealable bag	1000/10000
PPT070000-1	1000	Blue	N	N	Re-sealable bag	1000/10000
PPT071000	1000	Natural	N	Y	Re-sealable bag	1000/10000
PPT071000-1	1000	Blue	N	Y	Re-sealable bag	1000/10000
PPT170000	1000	Natural	Y	N	Re-sealable bag	1000/10000
PPT171000	1000	Natural	Y	Y	Re-sealable bag	1000/10000
PPT270000	1000	Natural	N	N	Rack box	96/1920
PPT271000	1000	Natural	N	Y	Rack box	96/1920
PPT370000	1000	Natural	Y	N	Rack box	96/1920
PPT371000	1000	Natural	N	Y	Rack box	96/1920

### Pipette Micro Tips (96 per bag)

Cat.No	Capacity(µl)	Color	Filter	Sterile	Packaging	Qty. per bag/case
PPT611010	10	Natural	N	Y	Re-sealable bag	96/1920
PPT631010	10	Natural	N	Y	Re-sealable bag	96/1920
PPT601200	200	Natural	N	Y	Re-sealable bag	96/1920
PPT601200-1	200	Natural	N	Y	Re-sealable bag	96/1920
PPT631300	300	Natural	N	Y	Re-sealable bag	96/1920
PPT601000	1000	Natural	N	Y	Re-sealable bag	96/1920
PPT601000-1	1000	Natural	N	Y	Re-sealable bag	96/1920
PPT701010	10	Natural	Y	Y	Re-sealable bag	96/1920
PPT703010	10	Natural	Y	Y	Re-sealable bag	96/1920
PPT701020	20	Natural	Y	Y	Re-sealable bag	96/1920
PPT701100	100	Natural	Y	Y	Re-sealable bag	96/1920
PPT701200	200	Natural	Y	Y	Re-sealable bag	96/1920
PPT701300	300	Natural	Y	Y	Re-sealable bag	96/1920
PPT701000	1000	Natural	Y	Y	Re-sealable bag	96/1920

### Robotic Tips

All JET products are designed by experienced engineers, and manufactured in 100,000 grade clean room environment, processes with premium materials. Before delivering to our customers, all products are accessed by a stringent QC process certified by ISO 9001, ISO 13485 quality management system, to assure the highest quality. We guarantee that all products are DNase/RNase-free, and non-pyrogenic to meet the highest standard of both laboratory experiment and clinical diagnostics.

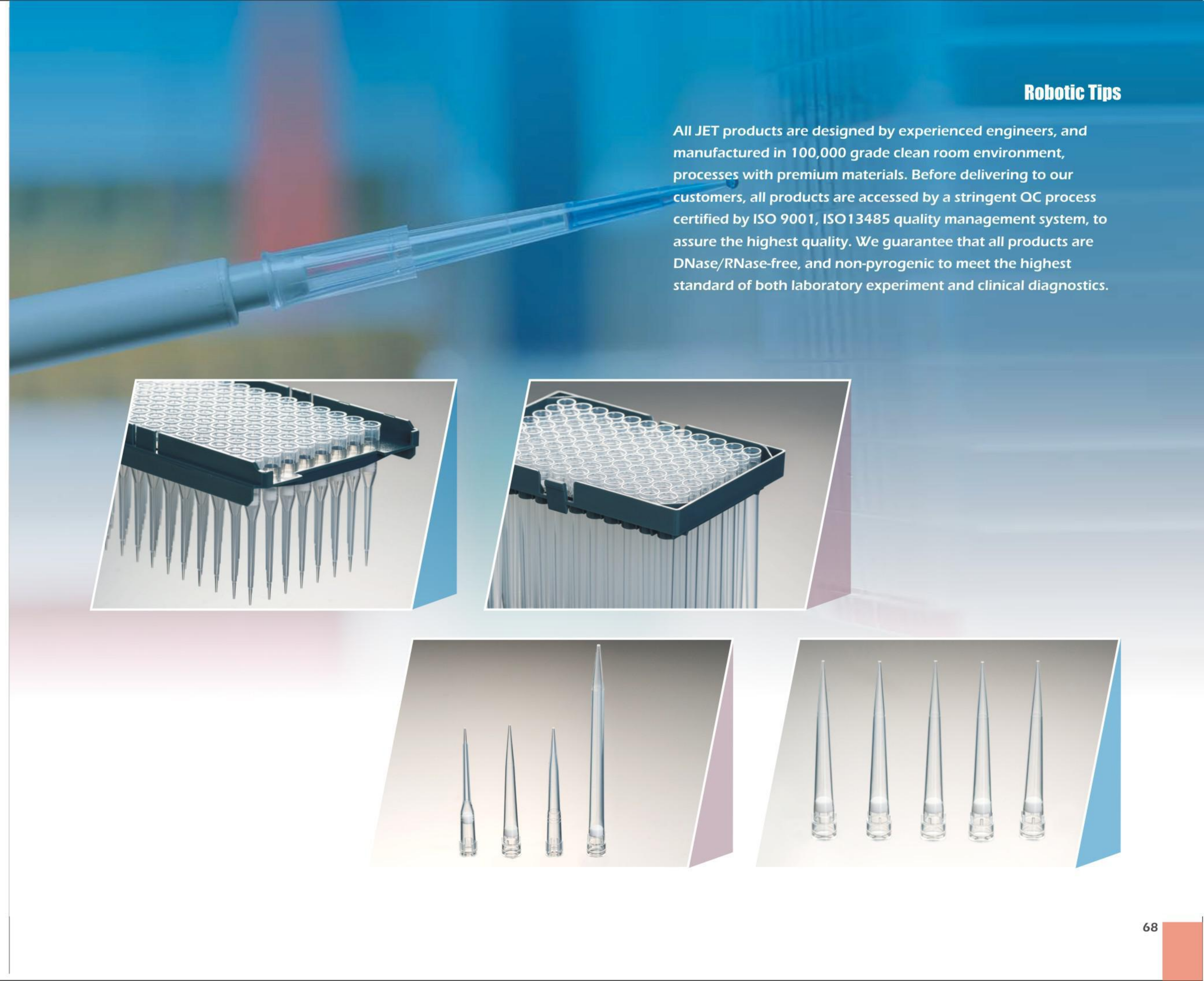

**JET** Robotic Tips are manufactured from super clear high quality Polypropylene. The surfaces of the tips are produced through a special process. This process makes the tip inner surface become hydrophobic, thus significantly reduces sample loss and provides substantially higher reproducibility when working with critical media.

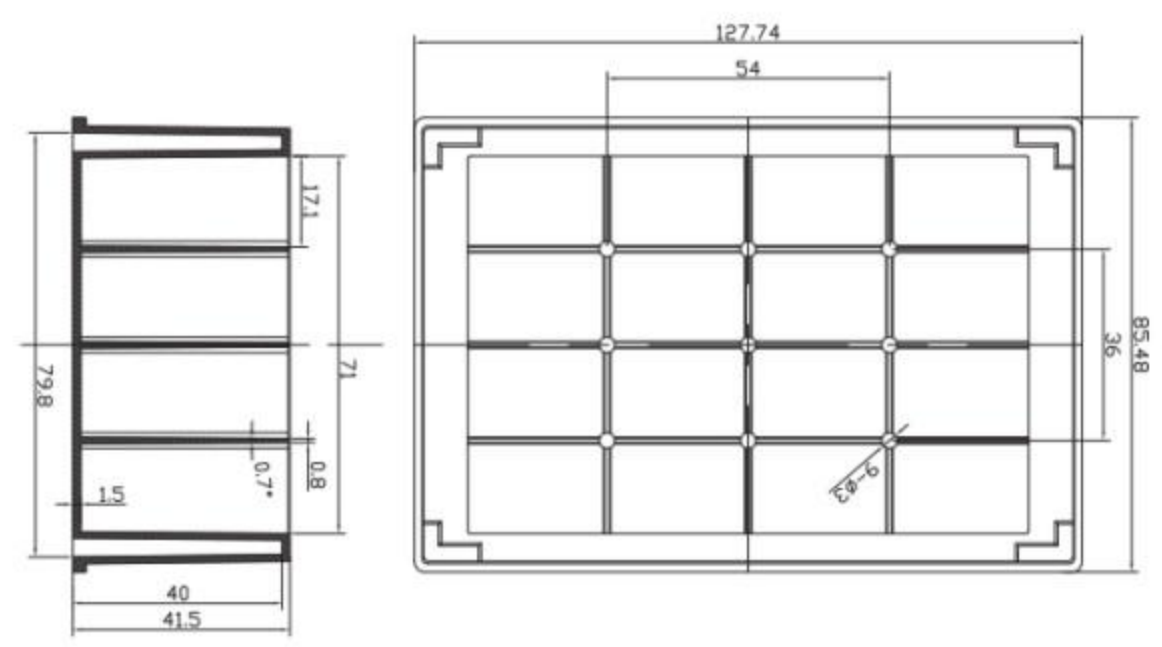
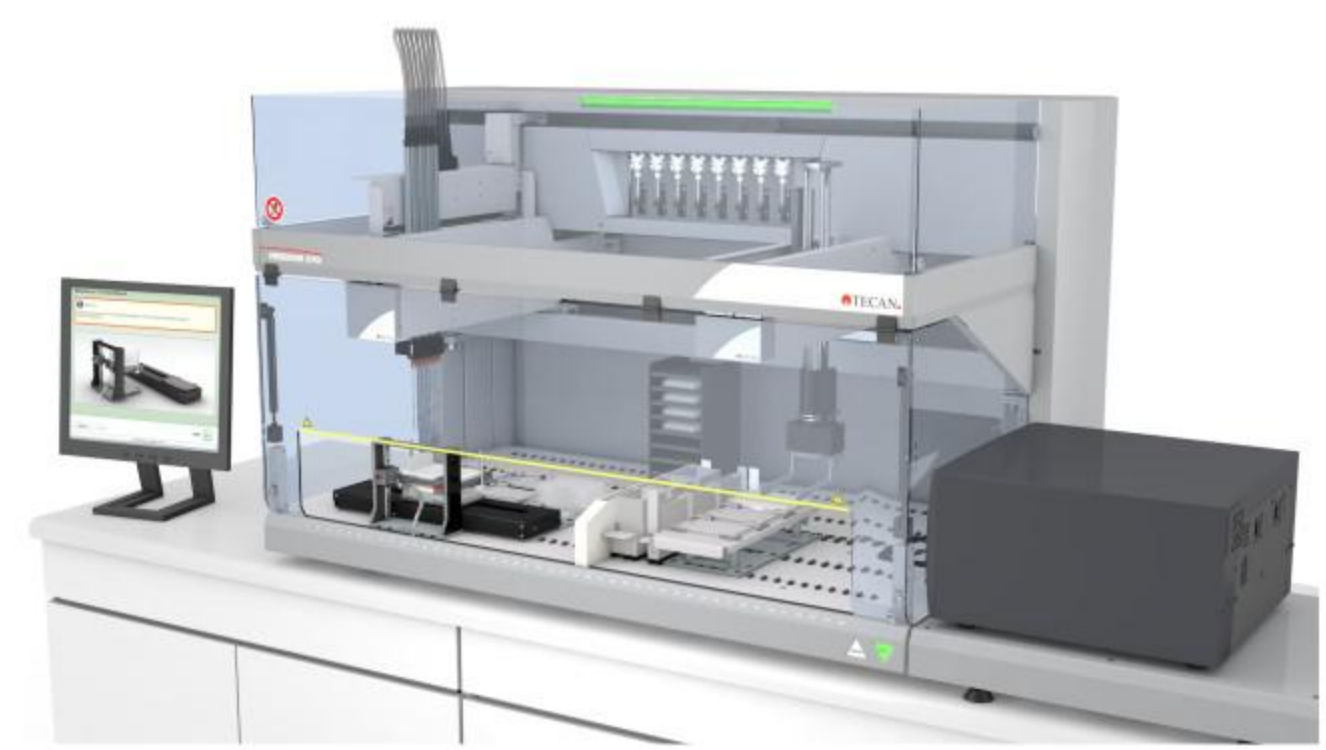

Tip format: 96 tip  
 Tip volume range: 20µl to 1000µl  
 Tip material: Clear/ Conductive polypropylene  
 RNase-/DNase-/human gDNA-free  
 Non-pyrogenic  
 Available options:  
 - With or without aerosol-resistant filters  
 - Non-sterile or sterile  
 - Low Retention/Standard surface

TECAN TP96 Genesis Freedom®, Freedom Evo® and Miniprep with LiHa, 96 Tip

Cat.No.	Max Volume	Description	Packaging Specification	Tip Color
ATT000020	20	Tecan Robotic Tips, Non-sterilized, Non-filtered	96 tips/rack, 24 packs/case	Natural
AMT000020	20	Tecan Robotic Tips, Low Retention, Non-filtered	96 tips/rack, 24 packs/case	Natural
ATT001020	20	Tecan Robotic Tips, Sterilized, Non-filtered	96 tips/rack, 24 packs/case	Natural
AMT001020	20	Tecan Robotic Tips, Sterilized, Low Retention	96 tips/rack, 24 packs/case	Natural
ATT101010	20	Tecan Robotic Tips, Sterilized, Filtered	96 tips/rack, 24 packs/case	Natural
AMT101010	20	Tecan Robotic Tips, Sterilized, Filtered, Low Retention	96 tips/rack, 24 packs/case	Natural
ATT000050	50	Tecan Robotic Tips, Non-sterilized, Non-filtered	96 tips/rack, 24 packs/case	Natural
AMT000050	50	Tecan Robotic Tips, Low Retention, Non-filtered	96 tips/rack, 24 packs/case	Natural
ATT001050	50	Tecan Robotic Tips, Sterilized, Non-filtered	96 tips/rack, 24 packs/case	Natural
AMT001050	50	Tecan Robotic Tips, Sterilized, Low Retention	96 tips/rack, 24 packs/case	Natural
ATT101050	50	Tecan Robotic Tips, Sterilized, Filtered	96 tips/rack, 24 packs/case	Natural
AMT101050	50	Tecan Robotic Tips, Sterilized, Filtered, Low Retention	96 tips/rack, 24 packs/case	Natural
ATT000200	200	Tecan Robotic Tips, Non-sterilized, Non-filtered	96 tips/rack, 24 packs/case	Natural
AMT000200	200	Tecan Robotic Tips, Low Retention, Non-filtered	96 tips/rack, 24 packs/case	Natural
ATT001200	200	Tecan Robotic Tips, Sterilized, Non-filtered	96 tips/rack, 24 packs/case	Natural
AMT001200	200	Tecan Robotic Tips, Sterilized, Low Retention	96 tips/rack, 24 packs/case	Natural
ATT101200	200	Tecan Robotic Tips, Sterilized, Filtered	96 tips/rack, 24 packs/case	Natural
AMT101200	200	Tecan Robotic Tips, Sterilized, Filtered, Low Retention	96 tips/rack, 24 packs/case	Natural
ATT000000	1000	Tecan Robotic Tips, Non-sterilized, Non-Filtered	96 tips/rack, 16 packs/case	Natural
AMT000000	1000	Tecan Robotic Tips, Low Retention, Non-filtered	96 tips/rack, 16 packs/case	Natural
ATT001000	1000	Tecan Robotic Tips, Sterilized, Non-filtered	96 tips/rack, 16 packs/case	Natural
AMT001000	1000	Tecan Robotic Tips, Sterilized, Low Retention	96 tips/rack, 16 packs/case	Natural
ATT101000	1000	Tecan Robotic Tips, Sterilized, Filtered	96 tips/rack, 16 packs/case	Natural
AMT101000	1000	Tecan Robotic Tips, Sterilized, Filtered, Low Retention	96 tips/rack, 16 packs/case	Natural



Tecan® Genesis Freedom®, Freedom Evo® and Miniprep with LiHa

Cat.No.	Max Volume	Description	Packaging Specification	Tip Color
AUT000020	20	Tecan Robotic Tips,Conductive,Non-sterilized,Non-filtered	96 tips/rack, 24 packs/case	Black
ANT000020	20	Tecan Robotic Tips,Conductive,Low Retention,Non-filtered	96 tips/rack, 24 packs/case	Black
AUT001020	20	Tecan Robotic Tips,Conductive,Sterilized,Non-filtered	96 tips/rack, 24 packs/case	Black
ANT001020	20	Tecan Robotic Tips, Conductive,Sterilized,Low Retention	96 tips/rack, 24 packs/case	Black
AUT101010	20	Tecan Robotic Tips,Conductive,Sterilized,Filtered	96 tips/rack, 24 packs/case	Black
ANT101010	20	Tecan Robotic Tips, Conductive,Sterilized,Filtered, Low Retention	96 tips/rack, 24 packs/case	Black
AUT000050	50	Tecan Robotic Tips,Conductive,Non-sterilized,Non-filtered	96 tips/rack, 24 packs/case	Black
ANT000050	50	Tecan Robotic Tips,Conductive,Low Retention,Non-filtered	96 tips/rack, 24 packs/case	Black
AUT001050	50	Tecan Robotic Tips,Conductive,Sterilized,Non-filtered	96 tips/rack, 24 packs/case	Black
ANT001050	50	Tecan Robotic Tips, Conductive,Sterilized,Low Retention	96 tips/rack, 24 packs/case	Black
AUT101050	50	Tecan Robotic Tips,Conductive,Sterilized,Filtered	96 tips/rack, 24 packs/case	Black
ANT101050	50	Tecan Robotic Tips, Conductive,Sterilized,Filtered, Low Retention	96 tips/rack, 24 packs/case	Black
AUT000200	200	Tecan Robotic Tips,Conductive,Non-sterilized,Non-filtered	96tips/rack, 24packs/case	Black
ANT000200	200	Tecan Robotic Tips,Conductive,Low Retention,Non-filtered	96tips/rack, 24packs/case	Black
AUT001200	200	Tecan Robotic Tips,Conductive,Sterilized,Non-filtered	96tips/rack, 24packs/case	Black
ANT001200	200	Tecan Robotic Tips, Conductive,Sterilized,Low Retention	96tips/rack, 24packs/case	Black
AUT101200	200	Tecan Robotic Tips,Conductive,Sterilized,Filtered	96tips/rack, 24packs/case	Black
ANT101200	200	Tecan Robotic Tips, Conductive,Sterilized,Filtered, Low Retention	96tips/rack, 24packs/case	Black
AUT000000	1000	Tecan Robotic Tips,Conductive,Non-sterilized,Non-filtered	96tips/rack, 16packs/case	Black
ANT000000	1000	Tecan Robotic Tips,Conductive,Low Retention,Non-filtered	96tips/rack, 16packs/case	Black
AUT001000	1000	Tecan Robotic Tips,Conductive,Sterilized,Non-filtered	96tips/rack, 16packs/case	Black
ANT001000	1000	Tecan Robotic Tips, Conductive,Sterilized,Low Retention	96tips/rack, 16packs/case	Black
AUT101000	1000	Tecan Robotic Tips,Conductive,Sterilized,Filtered	96tips/rack, 16packs/case	Black
ANT101000	1000	Tecan Robotic Tips, Conductive,Sterilized,Filtered, Low Retention	96tips/rack, 16packs/case	Black

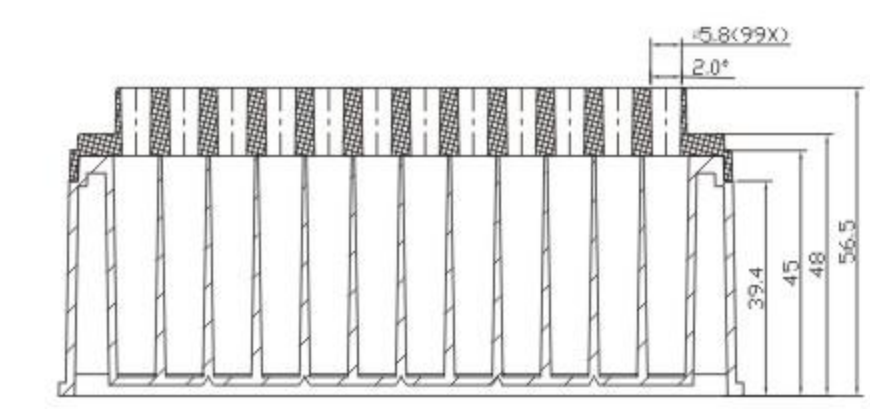
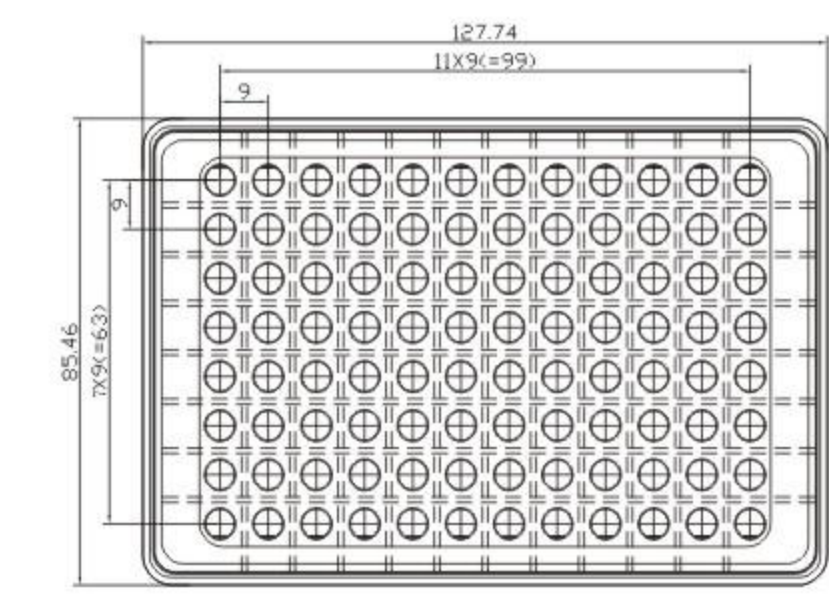

Tip format: 96 tip  
 Tip volume range: 20µl to 1000µl  
 Tip material: Clear/ Conductive polypropylene  
 RNase-/DNase-/human gDNA-free  
 Non-pyrogenic  
 Available options:  
 - With or without aerosol-resistant filters  
 - Non-sterile or sterile  
 - Low Retention/Standard surface

BECKMAN, FX/NX, Multimek AP96 and Biomek3000

Cat.No.	Max Volume	Description	Packaging Specification	Tip Color
ATB000020	20	Beckman Robotic Tips,Non-sterilized,Non-filtered	96 tips/rack, 10 racks/pack,5 packs/case	Natural
AMB000020	20	Beckman Robotic Tips,Low Retention,Non-filtered	96 tips/rack, 10 racks/pack,5 packs/case	Natural
ATB001020	20	Beckman Robotic Tips,Sterilized,Non-filtered	96 tips/rack, 10 racks/pack,5 packs/case	Natural
AMB001020	20	Beckman Robotic Tips, Sterilized,Low Retention	96 tips/rack, 10 racks/pack,5 packs/case	Natural
ATB101020	20	Beckman Robotic Tips,Sterilized,Filtered	96 tips/rack, 10 racks/pack,5 packs/case	Natural
AMB101020	20	Beckman Robotic Tips, Sterilized,Filtered, Low Retention	96 tips/rack, 10 racks/pack,5 packs/case	Natural
ATB000050	50	Beckman Robotic Tips,Non-sterilized,Non-filtered	96 tips/rack, 10 racks/pack,5 packs/case	Natural
AMB000050	50	Beckman Robotic Tips,Low Retention,Non-filtered	96 tips/rack, 10 racks/pack,5 packs/case	Natural
ATB001050	50	Beckman Robotic Tips,Sterilized,Non-filtered	96 tips/rack, 10 racks/pack,5 packs/case	Natural
AMB001050	50	Beckman Robotic Tips, Sterilized,Low Retention	96 tips/rack, 10 racks/pack,5 packs/case	Natural
ATB101050	50	Beckman Robotic Tips,Sterilized,Filtered	96 tips/rack, 10 racks/pack,5 packs/case	Natural
AMB101050	50	Beckman Robotic Tips, Sterilized,Filtered, Low Retention	96 tips/rack, 10 racks/pack,5 packs/case	Natural
ATB000250	250	Beckman Robotic Tips,Non-sterilized,Non-filtered	96 tips/rack, 10 racks/pack,5 packs/case	Natural
AMB000250	250	Beckman Robotic Tips,Low Retention,Non-filtered	96 tips/rack, 10 racks/pack,5 packs/case	Natural
ATB001250	250	Beckman Robotic Tips,Sterilized,Non-filtered	96 tips/rack, 10 racks/pack,5 packs/case	Natural
AMB001250	250	Beckman Robotic Tips, Sterilized,Low Retention	96 tips/rack, 10 racks/pack,5 packs/case	Natural
ATB101180	250	Beckman Robotic Tips,Sterilized,Filtered	96 tips/rack, 10 racks/pack,5 packs/case	Natural
AMB101180	250	Beckman Robotic Tips, Sterilized,Filtered, Low Retention	96 tips/rack, 10 racks/pack,5 packs/case	Natural
ATB000000	1000	Beckman Robotic Tips,Non-sterilized,Non-filtered	96 tips/rack,5 packs/case	Natural
AMB000000	1000	Beckman Robotic Tips,Low Retention,Non-filtered	96 tips/rack,5 packs/case	Natural
ATB001000	1000	Beckman Robotic Tips,Sterilized,Non-filtered	96 tips/rack,5 packs/case	Natural
AMB001000	1000	Beckman Robotic Tips, Sterilized,Low Retention	96 tips/rack,5 packs/case	Natural
ATB101000	1000	Beckman Robotic Tips,Sterilized,Filtered	96 tips/rack,5 packs/case	Natural
AMB101000	1000	Beckman Robotic Tips, Sterilized,Filtered, Low Retention	96 tips/rack,5 packs/case	Natural

BECKMAN, FX/NX, Multimek AP96 and Biomek3000

Cat.No.	Max Volume	Description	Packaging Specification	Tip Color
AUB000020	20	Beckman Robotic Tips,Conductive, Non-sterilized,Non-filtered	96 tips/rack, 10 racks/pack,5 packs/case	Black
ANB000020	20	Beckman Robotic Tips,Conductive, Low Retention,Non-filtered	96 tips/rack, 10 racks/pack,5 packs/case	Black
AUB001020	20	Beckman Robotic Tips,Conductive,Sterilized,Non-filtered	96 tips/rack, 10 racks/pack,5 packs/case	Black
ANB001020	20	Beckman Robotic Tips, Conductive, Sterilized,Low Retention	96 tips/rack, 10 racks/pack,5 packs/case	Black
AUB101020	20	Beckman Robotic Tips,Conductive, Sterilized,Filtered	96 tips/rack, 10 racks/pack,5 packs/case	Black
ANB101020	20	Beckman Robotic Tips, Conductive, Sterilized,Filtered, Low Retention	96 tips/rack, 10 racks/pack,5 packs/case	Black
AUB000050	50	Beckman Robotic Tips,Conductive, Non-sterilized,Non-filtered	96 tips/rack, 10 racks/pack,5 packs/case	Black
ANB000050	50	Beckman Robotic Tips,Conductive, Low Retention,Non-filtered	96 tips/rack, 10 racks/pack,5 packs/case	Black
AUB001050	50	Beckman Robotic Tips,Conductive, Sterilized,Non-filtered	96 tips/rack, 10 racks/pack,5 packs/case	Black
ANB001050	50	Beckman Robotic Tips, Conductive, Sterilized,Low Retention	96 tips/rack, 10 racks/pack,5 packs/case	Black
AUB101050	50	Beckman Robotic Tips,Conductive, Sterilized,Filtered	96 tips/rack, 10 racks/pack,5 packs/case	Black
ANB101050	50	Beckman Robotic Tips, Conductive, Sterilized,Filtered, Low Retention	96 tips/rack, 10 racks/pack,5 packs/case	Black
AUB000250	250	Beckman Robotic Tips,Conductive, Non-sterilized,Non-filtered	96 tips/rack, 10 racks/pack,5 packs/case	Black
ANB000250	250	Beckman Robotic Tips,Conductive, Low Retention,Non-filtered	96 tips/rack, 10 racks/pack,5 packs/case	Black
AUB001250	250	Beckman Robotic Tips,Conductive, Sterilized,Non-filtered	96 tips/rack, 10 racks/pack,5 packs/case	Black
ANB001250	250	Beckman Robotic Tips, Conductive, Sterilized,Low Retention	96 tips/rack, 10 racks/pack,5 packs/case	Black
AUB101180	250	Beckman Robotic Tips,Conductive, Sterilized,Filtered	96 tips/rack, 10 racks/pack,5 packs/case	Black
ANB101180	250	Beckman Robotic Tips, Conductive, Sterilized,Filtered, Low Retention	96 tips/rack, 10 racks/pack,5 packs/case	Black
AUB000000	1000	Beckman Robotic Tips,Conductive, Non-sterilized,Non-filtered	96 tips/rack,5 packs/case	Black
ANB000000	1000	Beckman Robotic Tips,Conductive, Low Retention,Non-filtered	96 tips/rack,5 packs/case	Black
AUB001000	1000	Beckman Robotic Tips,Conductive, Sterilized,Non-filtered	96 tips/rack,5 packs/case	Black
ANB001000	1000	Beckman Robotic Tips, Conductive, Sterilized,Low Retention	96 tips/rack,5 packs/case	Black
AUB101000	1000	Beckman Robotic Tips,Conductive, Sterilized,Filtered	96 tips/rack,5 packs/case	Black
ANB101000	1000	Beckman Robotic Tips, Conductive, Sterilized,Filtered, Low Retention	96 tips/rack,5 packs/case	Black

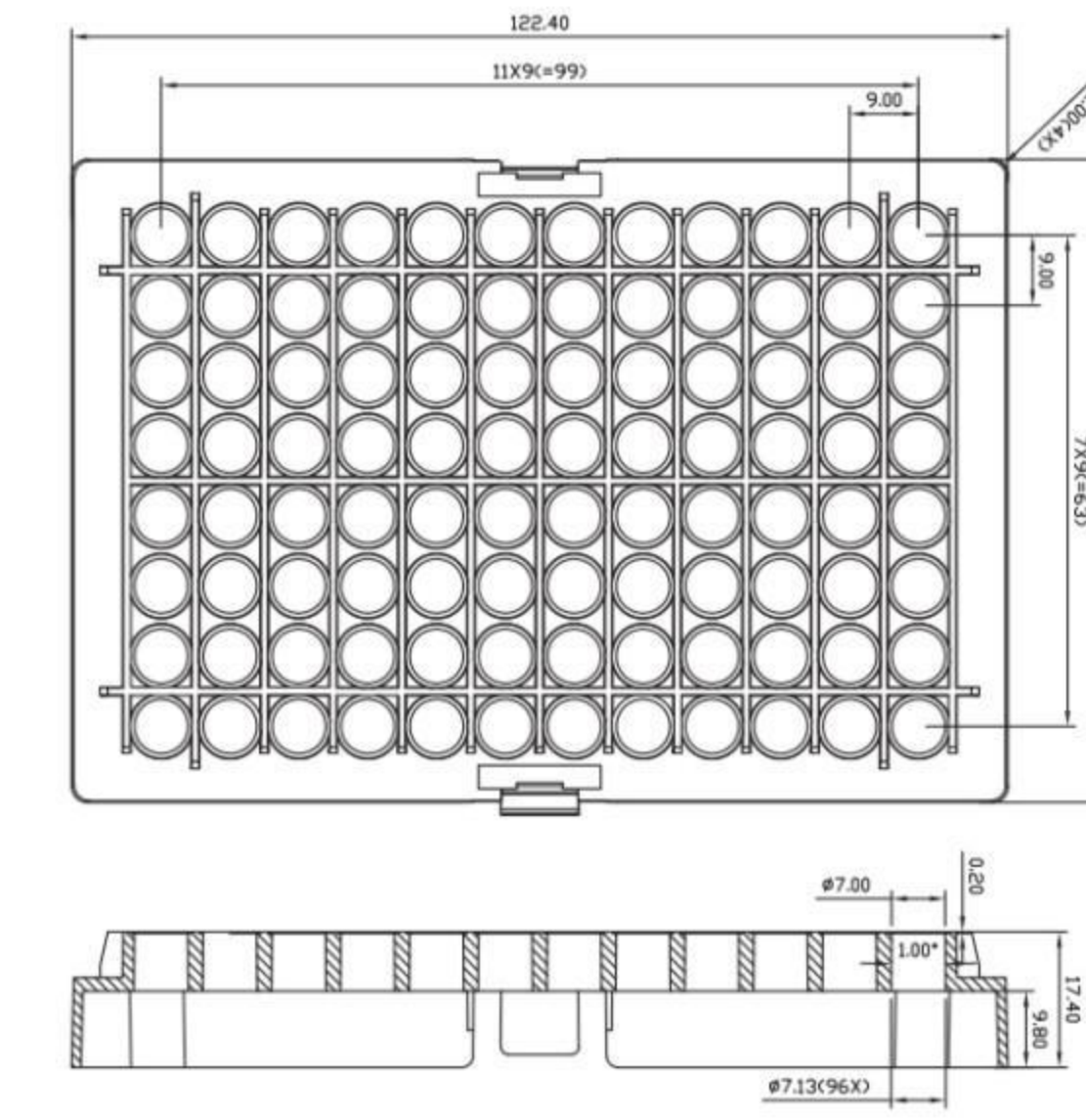

Tip format: 96 tip  
 Tip volume range: 50µl to 1000µl  
 Tip material: Clear/Conductive polypropylene  
 RNase-/DNase-/human gDNA-free  
 Non-pyrogenic  
 Available options:  
 - With or without aerosol-resistant filters  
 - Non-sterile or sterile  
 - Low Retention/Standard surface

Hamilton STAR, STARlet, STARplus and Nimbus®

Cat.No.	Max Volume	Description	Packaging Specification	Tip Color
ATH000050	50	Hamilton Robotic Tips, Non-sterilized, Non-filtered	96 tips/rack, 24 packs/case	Natural
AMH000050	50	Hamilton Robotic Tips, Low Retention, Non-filtered	96 tips/rack, 24 packs/case	Natural
ATH001050	50	Hamilton Robotic Tips, Sterilized, Non-filtered	96 tips/rack, 24 packs/case	Natural
AMH001050	50	Hamilton Robotic Tips, Sterilized, Low Retention	96 tips/rack, 24 packs/case	Natural
ATH101050	50	Hamilton Robotic Tips, Sterilized, Filtered	96 tips/rack, 24 packs/case	Natural
AMH101050	50	Hamilton Robotic Tips, Sterilized, Filtered, Low Retention	96 tips/rack, 24 packs/case	Natural
ATH000300	300	Hamilton Robotic Tips, Non-sterilized, Non-filtered	96 tips/rack, 24 packs/case	Natural
AMH000300	300	Hamilton Robotic Tips, Low Retention, Non-filtered	96 tips/rack, 24 packs/case	Natural
ATH001300	300	Hamilton Robotic Tips, Sterilized, Non-filtered	96 tips/rack, 24 packs/case	Natural
AMH001300	300	Hamilton Robotic Tips, Sterilized, Low Retention	96 tips/rack, 24 packs/case	Natural
ATH101300	300	Hamilton Robotic Tips, Sterilized, Filtered	96 tips/rack, 24 packs/case	Natural
AMH101300	300	Hamilton Robotic Tips, Sterilized, Filtered, Low Retention	96 tips/rack, 24 packs/case	Natural
ATH000000	1000	Hamilton Robotic Tips, Non-sterilized, Non-filtered	96 tips/rack, 16 packs/case	Natural
AMH000000	1000	Hamilton Robotic Tips, Low Retention, Non-filtered	96 tips/rack, 16 packs/case	Natural
ATH001000	1000	Hamilton Robotic Tips, Sterilized, Non-filtered	96 tips/rack, 16 packs/case	Natural
AMH001000	1000	Hamilton Robotic Tips, Sterilized, Low Retention	96 tips/rack, 16 packs/case	Natural
ATH101000	1000	Hamilton Robotic Tips, Sterilized, Filtered	96 tips/rack, 16 packs/case	Natural
AMH101000	1000	Hamilton Robotic Tips, Sterilized, Filtered, Low Retention	96 tips/rack, 16 packs/case	Natural

Hamilton STAR, STARlet, STARplus and Nimbus®

Cat.No.	Max Volume	Description	Packaging Specification	Tip Color
AUH000050	50	Hamilton Robotic Tips, Conductive, Non-sterilized,Non-filtered	96 tips/rack,24 packs/case	Black
ANH000050	50	Hamilton Robotic Tips, Conductive, Low Retention,Non-filtered	96 tips/rack,24 packs/case	Black
AUH001050	50	Hamilton Robotic Tips, Conductive, Sterilized,Non-filtered	96 tips/rack,24 packs/case	Black
ANH001050	50	Hamilton Robotic Tips, Conductive, Sterilized,Low Retention	96 tips/rack,24 packs/case	Black
AUH101050	50	Hamilton Robotic Tips, Conductive, Sterilized,Filtered	96 tips/rack,24 packs/case	Black
ANH101050	50	Hamilton Robotic Tips, Conductive, Sterilized,Filtered, Low Retention	96 tips/rack,24 packs/case	Black
AUH000300	300	Hamilton Robotic Tips, Conductive, Non-sterilized,Non-filtered	96 tips/rack,24 packs/case	Black
ANH000300	300	Hamilton Robotic Tips, Conductive, Low Retention,Non-filtered	96 tips/rack,24 packs/case	Black
AUH001300	300	Hamilton Robotic Tips, Conductive, Sterilized,Non-filtered	96 tips/rack,24 packs/case	Black
ANH001300	300	Hamilton Robotic Tips, Conductive, Sterilized,Low Retention	96 tips/rack,24 packs/case	Black
AUH101300	300	Hamilton Robotic Tips, Conductive, Sterilized,Filtered	96 tips/rack,24 packs/case	Black
ANH101300	300	Hamilton Robotic Tips, Conductive, Sterilized,Filtered, Low Retention	96 tips/rack,24 packs/case	Black
AUH000000	1000	Hamilton Robotic Tips, Conductive, Non-sterilized,Non-filtered	96tips/rack,16packs/case	Black
ANH000000	1000	Hamilton Robotic Tips, Conductive, Low Retention,Non-filtered	96tips/rack,16packs/case	Black
AUH001000	1000	Hamilton Robotic Tips, Conductive, Sterilized,Non-filtered	96tips/rack,16packs/case	Black
ANH001000	1000	Hamilton Robotic Tips, Conductive, Sterilized,Low Retention	96tips/rack,16packs/case	Black
AUH101000	1000	Hamilton Robotic Tips, Conductive, Sterilized,Filtered	96tips/rack,16packs/case	Black
ANH101000	1000	Hamilton Robotic Tips, Conductive, Sterilized,Filtered, Low Retention	96tips/rack,16packs/case	Black



## Other Laboratory Products

### ELISA Plates

**ELISA Plates are optimal products for ELISA and provide reliable performance in binding assays when consistent coating of wells is required.**

- \* ELISA Plates are optimal products for ELISA and provide reliable performance in binding assays when consistent coating of wells is required
- \* Available with 2 different protein binding capability well surface
- \* 2 different bottom styles, fixed flat bottom and detachable flat bottom
- \* 8 or 12 wells strip and 48 or 96 well detachable frames are supplied in order to satisfy different sample quantity and economize coat
- \* Well surface is uniform, smooth and free from striation to eliminate error
- \* CV of transmittance is less than 5.00%
- \* Wells are labeled with alphanumeric code for easy identification
- \* Sterilized by gamma irradiation

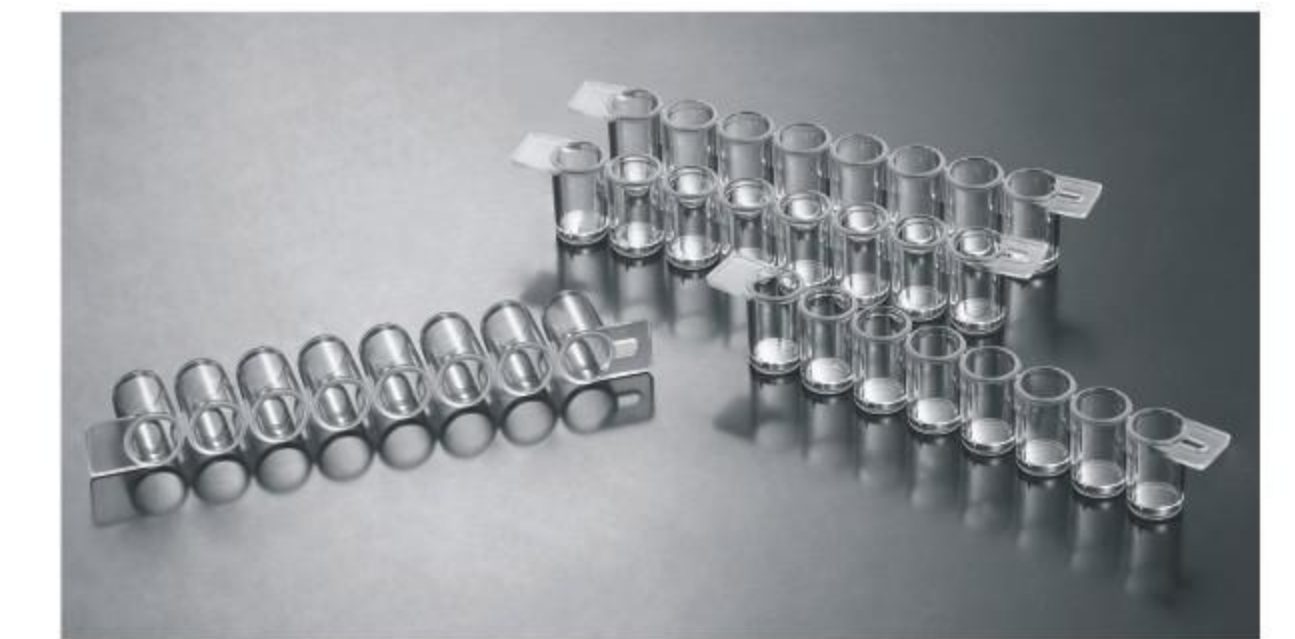

### Ordering Information

- \* Packaged in easy to open bag
- \* Well strips and plate frames are packed respectively
- \* Every case has printed lot No.for quality traceability



### Product Specifications and Details

Cat.No	Well Qty.	Binding Capacity	Description	Qty.per(bag/box)/case
FEP100096	96well	High Binding	Fixed Flat Bottom	10/200
FEP101896	96well		Detachable, 8x12	10/200
FEP101296	96well		Detachable, 12x8	10/200
FEP101248	48well		Detachable, Flat	20/400
FEP100012	12well	Medium Binding	Strip 12x8	40/1600
FEP100008	8well		Strip 8x12	60/2400
FEP200096	96well		Fixed Flat Bottom	10/200
FEP201896	96well		Detachable, 8x12	10/200
FEP201296	96well	Medium Binding	Detachable, 12x8	10/200
FEP201248	48well		Detachable, Flat	20/400
FEP200012	12well		Strip 12x8	40/1600
FEP200008	8well		Strip 8x12	60/2400

### ELISA Well Strips and Plate Frames

Cat.No	Size	Description	Qty. per bag/case
FEP400096	96well	Frame for 12w × 8 or 8w × 12well strips	10/200
FEP400048	48well	Frame for 12w × 4well strips	10/400

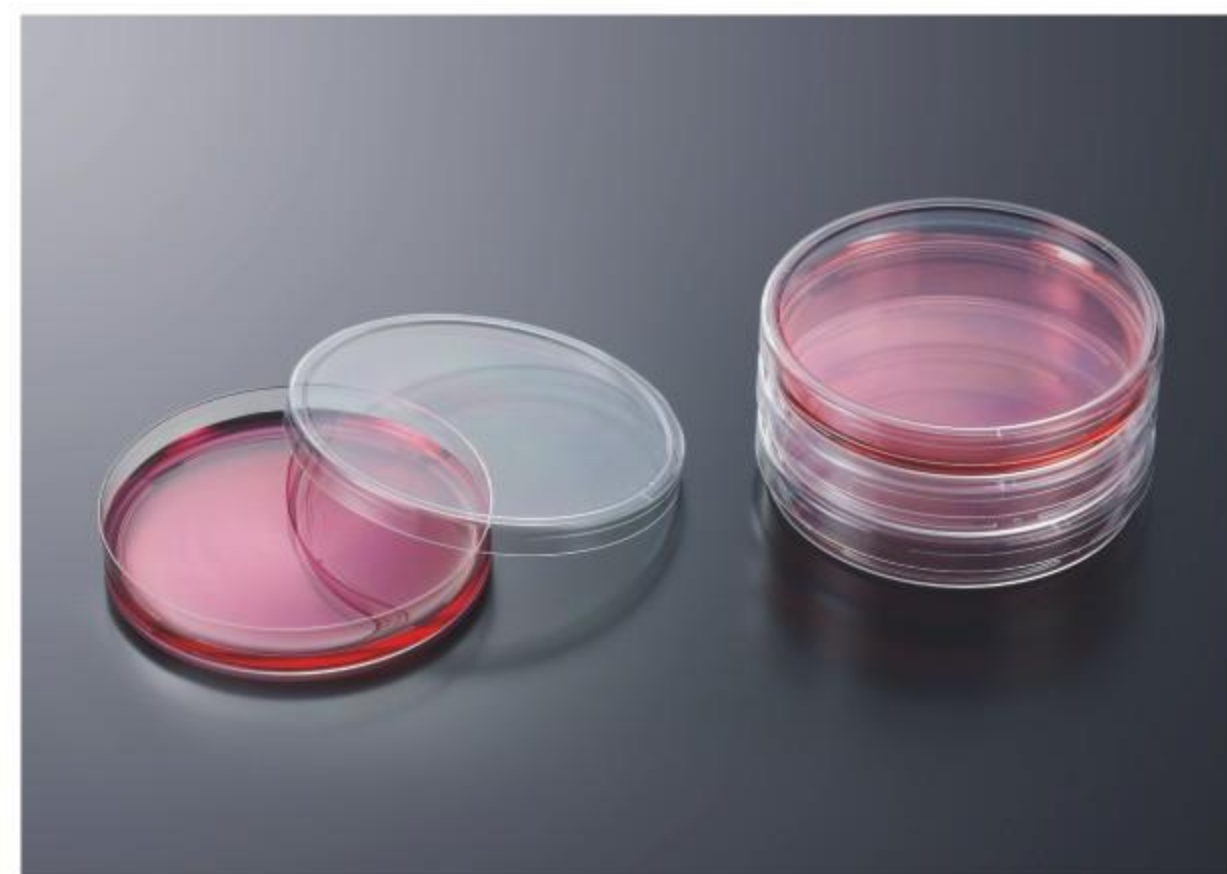

### Petri dishes

Petri dishes are containers for bacterial culture and also useful in sample separation, pre-treatment, storage and so on.

- \* Disposable Petri dish made of transparent polymer materials made of polystyrene (GPPS), for laboratory inoculation, scribing, bacterial operation
- \* Uniform thickness, bottom without distortion, good transparency, is easy to observe
- \* Can meet the training needs of gas exchange
- \* Easy grip type flat plate, lateral teeth ring design, minimizing pollution
- \* On the cover and the bottom annular protuberance closely, convenient storage and reduce the medium volatile
- \* Gamma ray sterilization

#### Ordering Information

- \* Packaged in durable and resealable (zip closure) to assure contamination-free
- \* Every package case is printed with lot No. for quality traceability

Cat.No	Diameter(cm)	Growth area(cm <sup>2</sup> )	SAL	Qty. per bag/case
MCD110090	9.0	55.0	10 <sup>-6</sup>	20/500
MCD010090	9.0	55.0	10 <sup>-3</sup>	20/500

Cat.No	Diameter(cm)	Growth area(cm <sup>2</sup> )	Lid	Sterile	Qty. per bag/case
MCD000035	3.5	8.5	Y	Y	10/960
MCD000060	6.0	21.2	Y	Y	10/600
MCD000070	7.0	36.3	Y	Y	10/600
MCD000090	9.0	58.4	Y	Y	10/500
MCD000150	15.0	143.0	Y	Y	1/120
MCD100150	15.0	143.0	Y	Y	5/100



### Reagent Reservoir

- \* Manufactured from high-quality polypropylene
- \* Low profile design, suitable for small volume robotic tips used in high flux instrument.
- \* In the automatic pipetting process, the reservoir can perfectly overcome the surface tension of the liquid and minimize residual liquid
- \* Matched reservoir breaker (for 96 and 384) and the cover can avoid the liquid wastage in the process of operation
- \* Minimum residual liquid; low heavy metal content
- \* Microplanes can be stored under subzero temperature from -40°C to -80°C
- \* DNase/RNase free and non-Pyrogenic

Cat.No	Volume(ml)	Lid	Well Qty.	Sterile	Qty.per box	Qty.per case
RES082022	22	N	8	N	10	50
RES083022	22	N	8	Y	10	50
RES122015	15	N	12	N	10	50
RES123015	15	N	12	Y	10	50
RES962095	195	N	96	N	10	50
RES963095	195	N	96	Y	10	50
RES842085	185	N	384	N	10	50
RES843085	185	N	384	Y	10	50

#### Ordering Information

- \* Plate and film are individually packaged
- \* Package in easy-to-open packs to assure contamination-free
- \* Every pack case is printed with lot No. for quality traceability
- \* Available in gamma irradiation sterilized or non-sterilized



### Reagent Reservoirs

Reagent Reservoirs are designed for liquid transfer, also the first assistant container choice for repetitive pipettors.

- \* Available with 3 sizes : 25ml, 50ml, 100ml
- \* Engraved graduation ensure accuracy
- \* Quiet handing and light weight
- \* Corrosion proof
- \* Tapped for nesting when stored
- \* Available in sterilized or non-sterilized
- \* Stability is strong, easy to operate, with scale

Cat.No	Volume(ml)	Color	Sterile	Qty. per bag/case
LTT012025	25	white	N	1/50
LTT052025	25	White	Y	5/100
LTT002025	25	White	N	1/100
LTT012050	50	White	Y	1/50
LTT052050	50	White	Y	5/100
LTT002050	50	White	Y	100
LTT000050	50	White	N	20/400
LTT001050	50	White	Y	20/400
LTT010050	50	White	Y	1/80
LTT011050	50	White	N	1/80
LTT012100	100	White	Y	1/50
LTT052100	100	White	Y	5/100
LTT002100	100	White	N	100

### PCR Tubes

PCR products are manufactured from prime virgin polypropylenes. This result in tubes, strips and tips that exhibit a perfect balance between transparency, softness, robustness, antistatic characteristics and gas tightness.

- \* 0.2ml thin wall PCR Tubes, Strip of 8 Tubes, Flat caps
- \* Manufactured from prime virgin polypropylene
- \* Ultra thin wall design for efficient heat transfer
- \* Compatible with standard 96 well heat blocks
- \* High light transmittance

#### Ordering Information

- \* Package in easy opening plastic bag and white box
- \* Every case has printed lot No. for quality traceability

Cat.No	Description	Sterile	Color	Qty. per bag/case
PCR100200	0.2ml PCR Tubes with Flat Cap, 8 Strips	Y	Natural	125/1250
PCR000200	0.2ml PCR Tubes with Flat Cap, Single	Y	Natural	1000/10000

### 96 Well PCR Plates

The well bottom is clear for maximum visibility. Available in assorted colors with clear or black alpha-numeric lettering. Compatible with standard multichannel pipettes.

#### Applications

- \* PCR
- \* qPCR/Real-Time PCR

#### Compatibility

Standard thermal cycling, BioRad qPCR systems, Statagene MX-3000:

- \* 0.3 mL maximum well volume (when used with adhesive or heat seals)
- \* Films and Foils, Heat Seals and Flat and Domed Cap Strips
- \* Compatible with 0.2ml thermal cyclers and ABI PRISM 3100, 3130 and 3700 capillary sequencers
- \* Suitable for 0.2ml thermal cycler blocks
- \* 100% Virgin Polypropylene construction for PCR application
- \* Slightly raised well to provide sealing with mats, film, foil, heat seals, and flat and domed cap strips
- \* Thin and uniform wall thickness for consistent thermal transfer
- \* DNase/RNase-free & Non-Pyrogenic

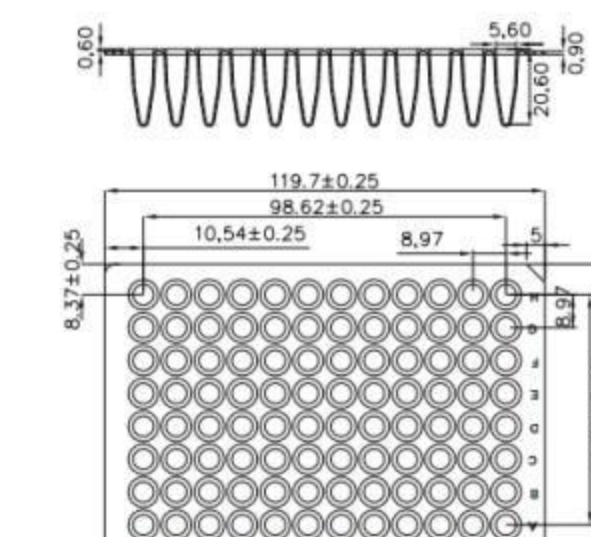
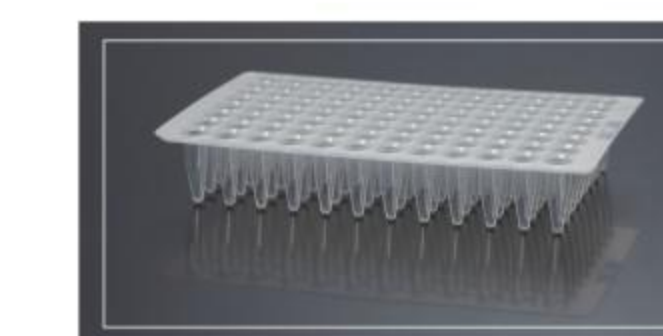
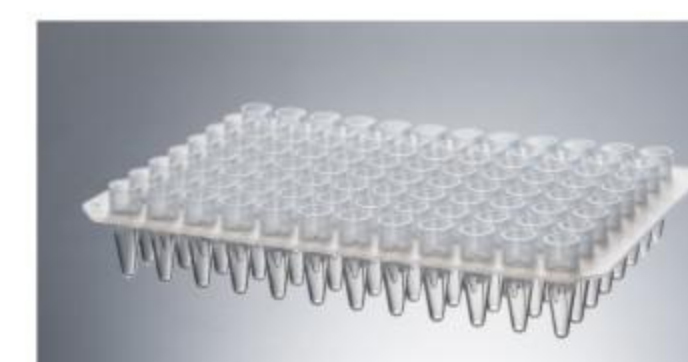
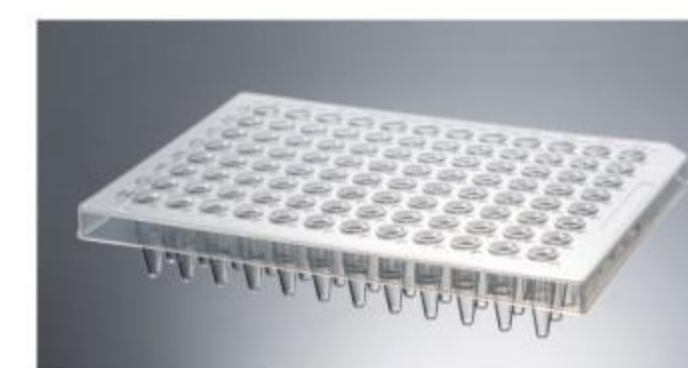

Cat.No	Description	Color	Qty.per.box/bag	Qty.per.box/case
PCR100096	PCR Plate 96 Well-Half-Skirted, non-sterilized	Natural	10	10
PCR200096	PCR Plate 96 Well-Skirted, non-sterilized	Natural	10	10
PCR300096	PCR Plate 96 Well-Non-skirted, non-sterilized	Natural	10	10



## Deep-well Multiwell Plates

Deep-well Multiwell Plates are excellent container as mother plates in cell and tissue culture assays requiring, sample storage and more.

- \* Manufactured from high-quality virgin polypropylene
- \* Available with 2 different wells: 48 wells and 96 wells
- \* Available with 6 different well volumes : 0.36 ml, 0.4 ml, 1.0 ml, 1.6 ml, 2.0 ml, 2.2 ml, 3.0 ml and 4.6 ml
- \* Resistant to a wide variety of chemicals
- \* Compatible with most robotic samplers and automated liquid handling systems
- \* Designed notched corners to facilitate orientation
- \* Stackable for easy storage
- \* Can be used with flexible mat covers reduce sample evaporation and contamination
- \* Evaporation and contamination
- \* Adhesive sealing films and pad are also available

### Ordering Information

- \* Plate and film are individually packaged
- \* Package in easy-to-open packs to assure contamination-free
- \* Every pack case is printed with lot No. for quality traceability
- \* Available in gamma irradiation sterilized or non-sterilized

Cat.No	Volume (ml)	Well Qty.	Bottom	Sterile	Qty. per box (bag)	Qty. per case
RWP102096	1.0	96	Round	N	24	96
RWP103096	1.0	96	Round	Y	24	96
RWP202096	2.0	96	Round	N	24	96
RWP203096	2.0	96	Round	Y	24	96
RWP352048	3.5	48	Round	N	24	96
RWP353048	3.5	48	Round	Y	24	96
VWP032096	0.36	96	Bottom	N	10	100
VWP033096	0.36	96	Bottom	Y	10	100
UWP042096	0.4	96	Bottom	N	10	100
UWP043096	0.4	96	Bottom	Y	10	100
DMP222096	2.2	96	square groove	N	24	96

Cat.No	Volume (ml)	Well Qty.	Bottom	Sterile	Qty. per box (bag)	Qty. per case
DMP222096	2.2	96	square groove	Y	24	96
DMP462048	4.6	48	square groove	N	24	96
DMP463048	4.6	48	square groove	Y	24	96
DMP160096	1.6	96	U Type well	N	1	1/50
DMP161096	1.6	96	U Type well	Y	1	1/50
DMP220096	2.2	96	U Type well	N	1	1/50
DMP221096	2.2	96	U Type well	Y	1	1/50
DMP010096	—	96	Sealing film	N	100	100/1000
DMP011096	—	96	Sealing film	Y	100	100/1000
DMP020096	—	96	Sealing pad	N	50	50/100
DMP021096	—	96	Sealing pad	Y	50	50/100

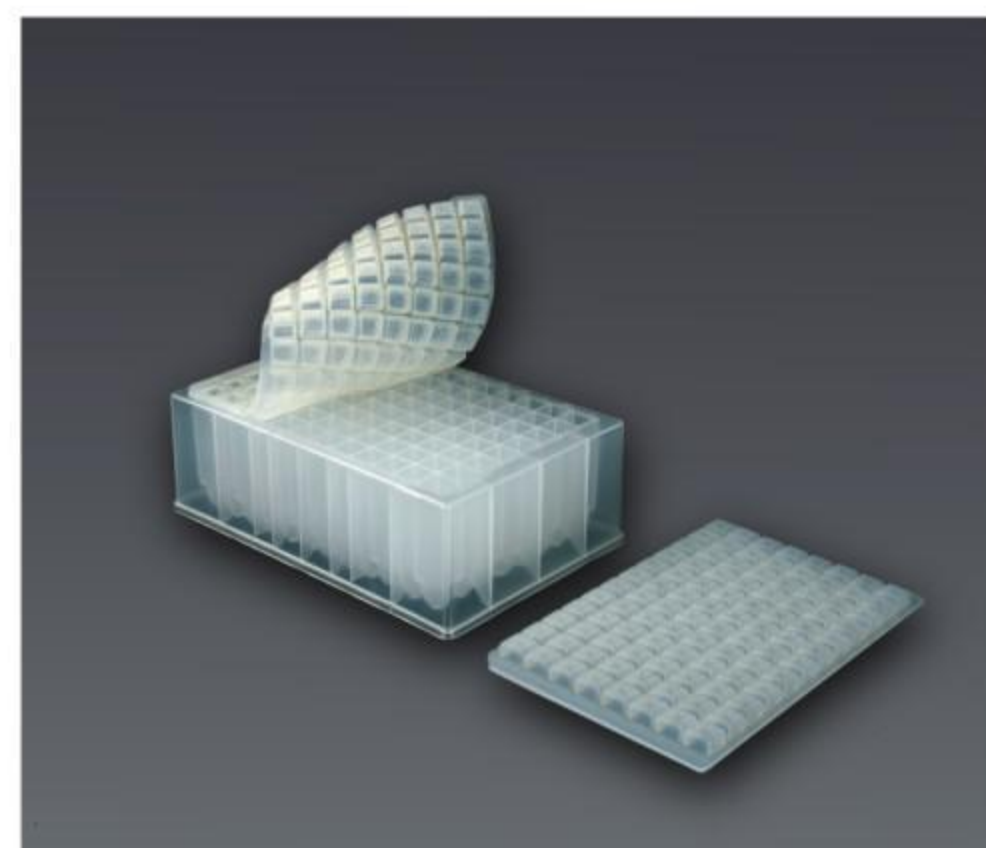

## Sample Library Tube

- \* Sample library tubes are designed for long-term specimen storage. Caps and tubes come in different packages
- \* Separate closures strips are available. 96 tube format with printed alpha numeric grid and a clear lid
- \* Library tubes available as: Individual tubes, 8-well, and 12-well tube strips Made of polypropylene. Autoclavable (122°C, 5 min) and freezable (-80°C)

Cat.No	Product Description	Packing Way
TUC000012	8-strip tube cap, natural, non-sterile	125 /bag, 1250 /case
TUC000013	8-strip tube cap, natural, sterile	125 /bag, 1250 /case
TUC000014	12-strip tube cap, natural, non-sterile	80 /bag, 800 /case
TUC000015	12-strip tube cap, natural, non-sterile	80 /bag, 800 /case
TUB000012	8-strip tube, no cap, natural, conical bottom, non-sterile	125 /bag, 1250 /case
TUB001012	12-strip tube, no cap, natural, conical bottom, non-sterile	80 /bag, 800 /case
TUB002012	Individual tube, no cap, natural, conical, non-sterile	1000/bag, 10000/case

Cat.No	Product Description	Packing Way
TUB003012	Individual tube, no cap, racked, natural, conical, non-sterile	96/rack, 10 racks/bag, 10 bags/case
TUB004012	Individual tube, no cap, racked, natural, conical, sterile	96/rack, 10 racks/bag, 10 bags/case
TUB005012	8-strip tube, no cap, racked, natural, conical, non-sterile	96/rack (12 strips), 10 racks/bag, 10 bags/case
TUB006012	8-strip tube, no cap, racked, natural, conical, sterile	96/rack (12 strips), 10 racks/bag, 10 bags/case
TUB007012	12-strip tube, no cap, racked, natural, conical, non-sterile	96/rack (8 strips), 10 racks/bag, 10 bags/case
TUB008012	12-strip tube, no cap, racked, natural, conical, sterile	96/rack (8 strips), 10 racks/bag, 10 bags/case



## Serum & Sample Tubes

Serum & Sample tubes are ideal processing applications for small volume sample.

- \* Excellent quality PP tube body and PE cap
- \* Available with 6 volumes of 0.5, 1.5, 2.0, 5.0, 15.0 and 50ml
- \* Screw cap with plug seal for one-handed operation
- \* Easy to read graduations are accurate to ±2%
- \* With a large unerasable frosting white writing area
- \* Leak proof
- \* Self standing
- \* Endotoxin free
- \* Non-sterilized tubes and gamma radiation sterilized tubes can be selected

### Ordering Information

- \* Packaged in easy to open packs to assure contamination free
- \* Every package case is printed with lot.No for quality traceability
- \* Available in gamma irradiation sterilized or non-sterilized

Cat.No	Volume [ml]	Speciality	Sterile	Qty. per bag/case
SST000005	0.5	Self-standing	N	50/5000
SST000015	1.5	Self-standing	N	50/5000
SST000020	2.0	Self-standing	N	20/5000
SST000050	5.0	Self-standing	N	20/2500
SST000150	15.0	Conical	N	25/500
SST000500	50.0	Self-standing	N	25/500
SST001005	0.5	Self-standing	Y	50/5000
SST001015	1.5	Self-standing	Y	50/5000
SST001020	2.0	Self-standing	Y	20/5000
SST001050	5.0	Self-standing	Y	20/2500
SST001150	15.0	Conical	Y	25/500
SST001500	50.0	Self-standing	Y	25/500

## Cuvettes

Cuvettes are select disposable products for their optics speciality and chemically resistant.

- \* Pure crystal clear virgin GPPS ensures the transparency
- \* Available with 2 standard volume sizes of 1.5ml and 4.5ml, 10mm path length
- \* CV of transmittance is less than 0.5%
- \* Resistant with most polar organic solvents
- \* Smooth sides make optical pathway no inflecting
- \* Recessed sides prevent scratching and convenient for grip

### Ordering Information

- \* Packaged in styrofoam box for extra protection
- \* Every package box is labeled with lot No for quality traceability

Cat.No	Material	Volume (ml)	Recommended working volume	Specification (mm × mm × mm)	Speciality	Qty. per box/case
CUV010015	PS	1.5	1~2.5ml	10 × 10 × 45	Two optical windows	100/1000
CUV010045	PS	4.5	3~4ml	10 × 10 × 45	Two optical windows	100/1000



## Graduated Urine Centrifuge Tubes

Centrifuge tubes are popular in samples centrifuging or storage in many research area.

- \* Molded graduations stand out distinctly on these optically clear polystyrene tubes
- \* Colorless and transparent are perfect for biological reaction experiments
- \* Meet the requirements of BSE/TST
- \* Latex Statement: This products is latex free
- \* Non-pyrogenic: The acceptance level for products is 0.05 EU/ml. (Tachypleus Amebocyte Lysate (TAL) Clot-gel test)
- \* Meet the requirements of ROHS
- \* Leak-proof
- \* DNase/RNase free
- \* Sterilized by gamma irradiation SAL 10<sup>6</sup> (ISO11137)

Cat.No	Capacity (ml)	Maximum RCF	Tube Shape	Tube Color	Cap Shape	Cap Color	Sterilization	Packaging Configuration
CFT418150	15	1500g	Conical-Bottom	Clear	Plug cap	Natural	No	Bluk 1000/CS
CFT419150	15	1500g	Conical-Bottom	Clear	Plug cap	Natural	No	100/Box, 10 Boxes/CS, 1000/CS
CFT420150	15	-	-	-	Plug cap	Natural	No	500/Bag, 2 Bags/CS, 1000/CS

